

## FEATURES

- Six independent ADCs**
- True bipolar analog inputs**
- Pin-/software-selectable ranges:  $\pm 10$  V,  $\pm 5$  V**
- Fast throughput rate: 250 kSPS**
- iCMOS™ process technology**
- Low power**
  - TBD mW at 250 kSPS with 5 V supplies
- Wide input bandwidth**
  - TBD dB SNR at 50 kHz input frequency
- On-chip reference and reference buffers**
- Parallel, serial, and daisy-chain interface modes**
- High speed serial interface**
  - SPI®-/QSPI™-/MICROWIRE™-/DSP-compatible
- Standby mode: 100  $\mu$ W max**
- 64-lead LQFP**

## APPLICATIONS

- Power line monitoring systems**
- Instrumentation and control systems**
- Multi-axis positioning systems**

## GENERAL DESCRIPTION

The AD7656-1/AD7657-1/AD7658-1<sup>1</sup> contain six 16-/14-/12-bit, fast, low power, successive approximation ADCs all in the one package that is designed on the iCMOS process (industrial CMOS). iCMOS is a process combining high voltage silicon with submicron CMOS and complementary bipolar technologies. It enables the development of a wide range of high performance analog ICs, capable of 33 V operation in a footprint that no previous generation of high voltage parts could achieve. Unlike analog ICs using conventional CMOS processes, iCMOS components can accept bipolar input signals while providing increased performance, which dramatically reduces power consumption and package size.

The AD7656-1/AD7657-1/AD7658-1 feature throughput rates up to 250 kSPS. The parts contain low noise, wide bandwidth, track-and-hold amplifiers that can handle input frequencies up to 12 MHz.

The conversion process and data acquisition are controlled using CONVST signals and an internal oscillator. Three

<sup>1</sup> Protected by U.S. Patent No. 6,731,232.

### Rev. PrC

Information furnished by Analog Devices is believed to be accurate and reliable. However, no responsibility is assumed by Analog Devices for its use, nor for any infringements of patents or other rights of third parties that may result from its use. Specifications subject to change without notice. No license is granted by implication or otherwise under any patent or patent rights of Analog Devices. Trademarks and registered trademarks are the property of their respective owners.

## FUNCTIONAL BLOCK DIAGRAM

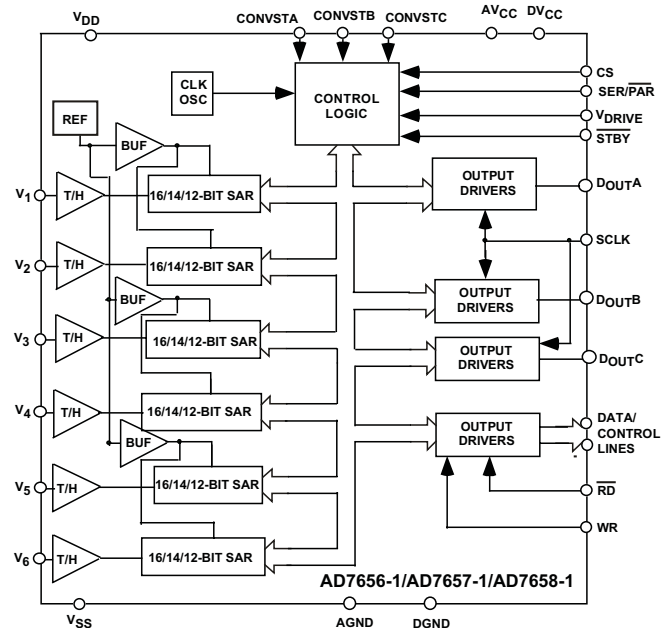

Figure 1.

CONVST pins allow independent, simultaneous sampling of the three ADC pairs. The AD7656-1/AD7657-1/AD7658-1 all have a high speed parallel and serial interface, allowing the devices to interface with microprocessors or DSPs. In serial interface mode, the parts have a daisy-chain feature that allows multiple ADCs to connect to a single serial interface. The AD7656-1/AD7657-1/AD7658-1 can accommodate true bipolar input signals in the  $\pm 4 \times V_{REF}$  range and  $\pm 2 \times V_{REF}$  range. The AD7656-1/AD7657-1/AD7658-1 also contain an on-chip 2.5 V reference.

## PRODUCT HIGHLIGHTS

1. Six 16-/14-/12-bit, 250 kSPS ADCs on board.
2. Six true bipolar, high impedance analog inputs.
3. Parallel and high speed serial interfaces.

## TABLE OF CONTENTS

Features .....	1	Pin Configuration and Function Descriptions.....	11
Applications.....	1	Typical Performance Characteristics .....	14
Functional Block Diagram .....	1	Terminology .....	18
General Description .....	1	Theory of Operation .....	20
Product Highlights .....	1	Converter Details .....	20
Revision History .....	2	ADC Transfer Function.....	21
Specifications.....	3	Reference Section .....	21
AD7656.....	3	Typical Connection Diagram .....	21
AD7657 .....	5	Driving the Analog Inputs .....	22
AD7658 .....	7	Interface Section.....	22
Timing Specifications .....	9	Application Hints .....	29
Absolute Maximum Ratings.....	10	Layout .....	29
Thermal Resistance .....	10	Outline Dimensions .....	30
ESD Caution.....	10	Ordering Guide .....	30

## REVISION HISTORY

## SPECIFICATIONS

### AD7656-1

$V_{REF} = 2.5$  V internal/external,  $AV_{CC} = 4.75$  V to 5.25 V,  $DV_{CC} = 4.75$  V to 5.25 V,  $V_{DRIVE} = 2.7$  V to 5.25 V;

For  $\pm 4 \times V_{REF}$  range:  $V_{DD} = 10$  V to 16.5 V,  $V_{SS} = -10$  V to  $-16.5$  V; For  $\pm 2 \times V_{REF}$  range:  $V_{DD} = 5$  V to 16.5 V,  $V_{SS} = -5$  V to  $-16.5$  V;

$f_{SAMPLE} = 250$  kSPS,  $T_A = T_{MIN}$  to  $T_{MAX}$ , unless otherwise noted.<sup>1</sup>

Table 1.

Parameter	B Version <sup>1</sup>	Y Version <sup>1</sup>	Unit	Test Conditions/Comments
<b>DYNAMIC PERFORMANCE</b>				
Signal-to-Noise + Distortion (SINAD) <sup>2</sup>	84	84	dB min	$f_{IN} = 50$ kHz sine wave
	85.5	85.5	dB typ	
Signal-to-Noise Ratio (SNR) <sup>2</sup>	85	85	dB min	
	86.5	86.5	dB typ	
Total Harmonic Distortion (THD) <sup>2</sup>	-90	-90	dB max	$V_{DD}/V_{SS} = \pm 5$ V to $\pm 10$ V
	-92	-92	dB typ	$V_{DD}/V_{SS} = \pm 12$ V to $\pm 16.5$ V
Peak Harmonic or Spurious Noise (SFDR) <sup>2</sup>	-100	-100	dB typ	
Intermodulation Distortion (IMD) <sup>2</sup>				$f_a = 50$ kHz, $f_b = 49$ kHz
Second-Order Terms	-112	-112	dB typ	
Third-Order Terms	-107	-107	dB typ	
Aperture Delay	10	10	ns max	
Aperture Delay Matching	4	4	ns max	
Aperture Jitter	35	35	ps typ	
Channel-to-Channel Isolation <sup>2</sup>	-100	-100	dB typ	$f_{IN}$ on unselected channels up to 100 kHz
Full Power Bandwidth	12	12	MHz typ	@ -3 dB
	2	2	MHz typ	@ -0.1 dB
<b>DC ACCURACY</b>				
Resolution	16	16	Bits	
No Missing Codes	15	14	Bits min	@ 25°C
	16	16	Bits min	
Integral Nonlinearity <sup>2</sup>	$\pm 3$	$\pm 4.5$	LSB max	
	$\pm 1$	$\pm 1$	LSB typ	
Positive Full-Scale Error <sup>2</sup>	$\pm 0.75$	$\pm 0.75$	% FS max	$\pm 0.22\%$ FSR typical
Positive Full-Scale Error Matching <sup>2</sup>	$\pm 0.35$	$\pm 0.35$	% FS max	
Bipolar Zero-Scale Error <sup>2</sup>	$\pm 0.023$	$\pm 0.023$	% FS max	$\pm 0.004\%$ FSR typical
Bipolar Zero-Scale Error Matching <sup>2</sup>	$\pm 0.038$	$\pm 0.038$	% FS max	
Negative Full-Scale Error <sup>2</sup>	$\pm 0.75$	$\pm 0.75$	% FS max	$\pm 0.22\%$ FSR typical
Negative Full-Scale Error Matching <sup>2</sup>	$\pm 0.35$	$\pm 0.35$	% FS max	
<b>ANALOG INPUT</b>				
Input Voltage Ranges	$\pm 4 \times V_{REF}$	$\pm 4 \times V_{REF}$	V	See Table 8 for min $V_{DD}/V_{SS}$ for each range
	$\pm 2 \times V_{REF}$	$\pm 2 \times V_{REF}$	V	RNG bit/RANGE pin = 0
DC Leakage Current	$\pm 1$	$\pm 1$	$\mu$ A max	RNG bit/RANGE pin = 1
Input Capacitance <sup>3</sup>	10	10	pF typ	$\pm 4 \times V_{REF}$ range when in track
	14	14	pF typ	$\pm 2 \times V_{REF}$ range when in track
<b>REFERENCE INPUT/OUTPUT</b>				
Reference Input Voltage Range	2.5	2.5	V min/max	
DC Leakage Current	$\pm 1$	$\pm 1$	$\mu$ A max	
Input Capacitance <sup>3</sup>	18.5	18.5	pF typ	$REF_{EN/DIS} = 1$
Reference Output Voltage	2.49/2.51	2.49/2.51	V min/max	
Long-Term Stability	150	150	ppm typ	1,000 hours
Reference Temperature Coefficient	25	25	ppm/°C max	
	6	6	ppm/°C typ	

Parameter	B Version <sup>1</sup>	Y Version <sup>1</sup>	Unit	Test Conditions/Comments
<b>LOGIC INPUTS</b>				
Input High Voltage ( $V_{INH}$ )	$0.7 \times V_{DRIVE}$	$0.7 \times V_{DRIVE}$	V min	Typically 10 nA, $V_{IN} = 0\text{ V}$ or $V_{DRIVE}$
Input Low Voltage ( $V_{INL}$ )	$0.3 \times V_{DRIVE}$	$0.3 \times V_{DRIVE}$	V max	
Input Current ( $I_{IN}$ )	$\pm 1$	$\pm 1$	$\mu\text{A}$ max	
Input Capacitance ( $C_{IN}$ ) <sup>3</sup>	10	10	pF max	
<b>LOGIC OUTPUTS</b>				
Output High Voltage ( $V_{OH}$ )	$V_{DRIVE} - 0.2$	$V_{DRIVE} - 0.2$	V min	$I_{SOURCE} = 200\ \mu\text{A}$ $I_{SINK} = 200\ \mu\text{A}$
Output Low Voltage ( $V_{OL}$ )	0.2	0.2	V max	
Floating-State Leakage Current	$\pm 1$	$\pm 1$	$\mu\text{A}$ max	
Floating-State Output Capacitance <sup>3</sup>	10	10	pF max	
Output Coding	Twos complement			
<b>CONVERSION RATE</b>				
Conversion Time	3.1	3.1	$\mu\text{s}$ max	Parallel interface mode only
Track-and-Hold Acquisition Time <sup>2,3</sup>	550	550	ns max	
Throughput Rate	250	250	kSPS	
<b>POWER REQUIREMENTS</b>				
$V_{DD}$	5/15	5/15	V nom min/max	For 4 x $V_{REF}$ range, $V_{DD} = 10\text{ V}$ to 16.5 V
$V_{SS}$	-5/-15	-5/-15	V nom min/max	For 4 x $V_{REF}$ range, $V_{DD} = -10\text{ V}$ to -16.5 V
$AV_{CC}$	5	5	V nom	
$DV_{CC}$	5	5	V nom	
$V_{DRIVE}$	3/5	3/5	V nom min/max	
$I_{TOTAL}$				Digital $I/P_S = 0\text{ V}$ or $V_{DRIVE}$
Normal Mode (Static) (Includes $I_{AV_{CC}}$ , $I_{V_{DD}}$ , $I_{V_{SS}}$ , $I_{V_{DRIVE}}$ , $I_{DV_{CC}}$ )	28	28	mA max	$AV_{CC} = DV_{CC} = V_{DRIVE} = 5.25\text{ V}$ , $V_{DD} = 16.5\text{ V}$ , $V_{SS} = -16.5\text{ V}$
Normal Mode (Operational) (Includes $I_{AV_{CC}}$ , $I_{V_{DD}}$ , $I_{V_{SS}}$ , $I_{V_{DRIVE}}$ , $I_{DV_{CC}}$ )	TBD	TBD	mA max	$f_{SAMPLE} = 250\text{ kSPS}$ , $AV_{CC} = DV_{CC} = V_{DRIVE} = 5.25\text{ V}$ , $V_{DD} = 16.5\text{ V}$ , $V_{SS} = -16.5\text{ V}$
$I_{SS}$ (Operational)	0.25	0.25	mA max	$V_{SS} = -16.5\text{ V}$ , $f_{SAMPLE} = 250\text{ kSPS}$
$I_{DD}$ (Operational)	0.25	0.25	mA max	$V_{DD} = 16.5\text{ V}$ , $f_{SAMPLE} = 250\text{ kSPS}$
Partial Power-Down Mode	7	7	mA max	$AV_{CC} = DV_{CC} = V_{DRIVE} = 5.25\text{ V}$ , $V_{DD} = 16.5\text{ V}$ , $V_{SS} = -16.5\text{ V}$
Full Power-Down Mode ( $\overline{STBY}$ Pin)	80	80	$\mu\text{A}$ max	SCLK on or off, $AV_{CC} = DV_{CC} = V_{DRIVE} = 5.25\text{ V}$ , $V_{DD} = 16.5\text{ V}$ , $V_{SS} = -16.5\text{ V}$
Power Dissipation				$AV_{CC} = DV_{CC} = V_{DRIVE} = 5.25\text{ V}$ , $V_{DD} = 16.5\text{ V}$ , $V_{SS} = -16.5\text{ V}$
Normal Mode (Static)	143	143	mW max	
Normal Mode (Operational)	TBD	TBD	mW max	$f_{SAMPLE} = 250\text{ kSPS}$
Partial Power-Down Mode	35	35	mW max	
Full Power-Down Mode ( $\overline{STBY}$ Pin)	100	100	$\mu\text{W}$ max	

<sup>1</sup> Temperature ranges are as follows: B version is  $-40^\circ\text{C}$  to  $+85^\circ\text{C}$ , Y version is  $-40^\circ\text{C}$  to  $+125^\circ\text{C}$ .

<sup>2</sup> See the Terminology section.

<sup>3</sup> Sample tested during initial release to ensure compliance.

**AD7657-1**

$V_{REF} = 2.5\text{ V}$  internal/external,  $AV_{CC} = 4.75\text{ V}$  to  $5.25\text{ V}$ ,  $DV_{CC} = 4.75\text{ V}$  to  $5.25\text{ V}$ ,  $V_{DRIVE} = 2.7\text{ V}$  to  $5.25\text{ V}$ ;

For  $\pm 4 \times V_{REF}$  range:  $V_{DD} = 10\text{ V}$  to  $16.5\text{ V}$ ,  $V_{SS} = -10\text{ V}$  to  $-16.5\text{ V}$ ; For  $\pm 2 \times V_{REF}$  range:  $V_{DD} = 5\text{ V}$  to  $16.5\text{ V}$ ,  $V_{SS} = -5\text{ V}$  to  $-16.5\text{ V}$ ;

$f_{SAMPLE} = 250\text{ kSPS}$ ,  $T_A = T_{MIN}$  to  $T_{MAX}$ , unless otherwise noted.<sup>1</sup>

**Table 2.**

Parameter	B Version <sup>1</sup>	Y Version <sup>1</sup>	Unit	Test Conditions/Comments
<b>DYNAMIC PERFORMANCE</b>				
Signal-to-Noise + Distortion (SINAD) <sup>2</sup>	81.5	81.5	dB min	$f_{IN} = 50\text{ kHz}$ sine wave
Signal-to-Noise Ratio (SNR) <sup>2</sup>	82.5	82.5	dB min	
	83.5	83.5	dB typ	
Total Harmonic Distortion (THD) <sup>2</sup>	-90	-89	dB max	
	-92	-92	dB typ	
Peak Harmonic or Spurious Noise (SFDR) <sup>2</sup>	-100	-100	dB typ	
Intermodulation Distortion (IMD) <sup>2</sup>				$f_a = 50\text{ kHz}$ , $f_b = 49\text{ kHz}$
Second-Order Terms	-109	-109	dB typ	
Third-Order Terms	-104	-104	dB typ	
Aperture Delay	10	10	ns max	
Aperture Delay Matching	4	4	ns max	
Aperture Jitter	35	35	ps typ	
Channel-to-Channel Isolation <sup>2</sup>	-100	-100	dB typ	$f_{IN}$ on unselected channels up to $100\text{ kHz}$
Full Power Bandwidth	12	12	MHz typ	@ -3 dB
	2	2	MHz typ	@ -0.1 dB
<b>DC ACCURACY</b>				
Resolution	14	14	Bits	
No Missing Codes	14	14	Bits min	
Integral Nonlinearity <sup>2</sup>	$\pm 1.5$	$\pm 1.5$	LSB max	
	$\pm 1$	$\pm 1$	LSB typ	
Positive Full-Scale Error <sup>2</sup>	$\pm 0.61$	$\pm 0.61$	% FS max	$\pm 0.183\%$ FSR typical
Positive Full-Scale Error Matching <sup>2</sup>	$\pm 0.3$	$\pm 0.3$	% FS max	
Bipolar Zero-Scale Error <sup>2</sup>	$\pm 0.0305$	$\pm 0.0305$	% FS max	$\pm 0.015\%$ FSR typical
Bipolar Zero-Scale Error Matching <sup>2</sup>	$\pm 0.0427$	$\pm 0.0427$	% FS max	
Negative Full-Scale Error <sup>2</sup>	$\pm 0.61$	$\pm 0.61$	% FS max	$\pm 0.183\%$ FSR typical
Negative Full-Scale Error Matching <sup>2</sup>	$\pm 0.3$	$\pm 0.3$	% FS max	
<b>ANALOG INPUT</b>				
Input Voltage Ranges	$\pm 4 \times V_{REF}$	$\pm 4 \times V_{REF}$	V	See Table 8 for min $V_{DD}/V_{SS}$ for each range
	$\pm 2 \times V_{REF}$	$\pm 2 \times V_{REF}$	V	RNG bit/RANGE pin = 0
DC Leakage Current	$\pm 1$	$\pm 1$	$\mu\text{A}$ max	RNG bit/RANGE pin = 1
Input Capacitance <sup>3</sup>	10	10	pF typ	$\pm 4 \times V_{REF}$ range when in track
	14	14	pF typ	$\pm 2 \times V_{REF}$ range when in track
<b>REFERENCE INPUT/OUTPUT</b>				
Reference Input Voltage Range	2.5	2.5	V min/max	
DC Leakage Current	$\pm 1$	$\pm 1$	$\mu\text{A}$ max	
Input Capacitance <sup>3</sup>	18.5	18.5	pF typ	$REF_{EN/DIS} = 1$
Reference Output Voltage	2.49/2.51	2.49/2.51	V min/max	
Long-Term Stability	150	150	ppm typ	1,000 hours
Reference Temperature Coefficient	25	25	ppm/ $^{\circ}\text{C}$ max	
	6	6	ppm/ $^{\circ}\text{C}$ typ	
<b>LOGIC INPUTS</b>				
Input High Voltage ( $V_{INH}$ )	$0.7 \times V_{DRIVE}$	$0.7 \times V_{DRIVE}$	V min	
Input Low Voltage ( $V_{INL}$ )	$0.3 \times V_{DRIVE}$	$0.3 \times V_{DRIVE}$	V max	
Input Current ( $I_{IN}$ )	$\pm 1$	$\pm 1$	$\mu\text{A}$ max	Typically $10\text{ nA}$ , $V_{IN} = 0\text{ V}$ or $V_{DRIVE}$
Input Capacitance ( $C_{IN}$ ) <sup>3</sup>	10	10	pF max	

Parameter	B Version <sup>1</sup>	Y Version <sup>1</sup>	Unit	Test Conditions/Comments
<b>LOGIC OUTPUTS</b>				
Output High Voltage ( $V_{OH}$ )	$V_{DRIVE} - 0.2$	$V_{DRIVE} - 0.2$	V min	$I_{SOURCE} = 200 \mu A$ $I_{SINK} = 200 \mu A$
Output Low Voltage ( $V_{OL}$ )	0.2	0.2	V max	
Floating-State Leakage Current	$\pm 1$	$\pm 1$	$\mu A$ max	
Floating-State Output Capacitance <sup>3</sup>	10	10	pF max	
Output Coding	Twos complement			
<b>CONVERSION RATE</b>				
Conversion Time	3.1	3.1	$\mu s$ max	Parallel interface mode only
Track-and-Hold Acquisition Time <sup>2,3</sup>	550	550	ns max	
Throughput Rate	250	250	kSPS	
<b>POWER REQUIREMENTS</b>				
$V_{DD}$	5/15	5/15	V nom min/max	For 4 x $V_{REF}$ range, $V_{DD} = 10 V$ to 16.5 V For 4 x $V_{REF}$ range, $V_{DD} = -10 V$ to -16.5 V
$V_{SS}$	-5/-15	-5/-15	V nom min/max	
$AV_{CC}$	5	5	V nom	Digital I/Ps = 0 V or $V_{DRIVE}$ $AV_{CC} = DV_{CC} = V_{DRIVE} = 5.25 V$ , $V_{DD} = 16.5 V$ , $V_{SS} = -16.5 V$ $f_{SAMPLE} = 250$ kSPS, $AV_{CC} = DV_{CC} = V_{DRIVE} = 5.25 V$ , $V_{DD} = 16.5 V$ , $V_{SS} = -16.5 V$ $V_{SS} = -16.5 V$ , $f_{SAMPLE} = 250$ kSPS $V_{DD} = 16.5 V$ , $f_{SAMPLE} = 250$ kSPS $AV_{CC} = DV_{CC} = V_{DRIVE} = 5.25 V$ , $V_{DD} = 16.5 V$ , $V_{SS} = -16.5 V$ SCLK on or off, $AV_{CC} = DV_{CC} = V_{DRIVE} = 5.25 V$ , $V_{DD} = 16.5 V$ , $V_{SS} = -16.5 V$ $AV_{CC} = DV_{CC} = V_{DRIVE} = 5.25 V$ , $V_{DD} = 16.5 V$ , $V_{SS} = -16.5 V$  $f_{SAMPLE} = 250$ kSPS
$DV_{CC}$	5	5	V nom	
$V_{DRIVE}$	3/5	3/5	V nom min/max	
$I_{TOTAL}$				
Normal Mode (Static) (Includes $I_{AV_{CC}}$ , $I_{V_{DD}}$ , $I_{V_{SS}}$ , $I_{V_{DRIVE}}$ , $I_{DV_{CC}}$ )	28	28	mA max	
Normal Mode (Operational) (Includes $I_{AV_{CC}}$ , $I_{V_{DD}}$ , $I_{V_{SS}}$ , $I_{V_{DRIVE}}$ , $I_{DV_{CC}}$ )	TBD	TBD	mA max	
$I_{SS}$ (Operational)	0.25	0.25	mA max	
$I_{DD}$ (Operational)	0.25	0.25	mA max	
Partial Power-Down Mode	7	7	mA max	
Full Power-Down Mode ( $\overline{STBY}$ Pin)	80	80	$\mu A$ max	
Power Dissipation				
Normal Mode (Static)	143	143	mW max	
Normal Mode (Operational)	TBD	TBD	mW max	
Partial Power-Down Mode	35	35	mW max	
Full Power-Down Mode ( $\overline{STBY}$ Pin)	100	100	$\mu W$ max	

<sup>1</sup> Temperature ranges are as follows: B version is -40°C to +85°C, Y version is -40°C to +125°C.

<sup>2</sup> See the Terminology section.

<sup>3</sup> Sample tested during initial release to ensure compliance.

**AD7658-1**

$V_{REF} = 2.5\text{ V}$  internal/external,  $AV_{CC} = 4.75\text{ V}$  to  $5.25\text{ V}$ ,  $DV_{CC} = 4.75\text{ V}$  to  $5.25\text{ V}$ ,  $V_{DRIVE} = 2.7\text{ V}$  to  $5.25\text{ V}$ ;  
 For  $\pm 4 \times V_{REF}$  range:  $V_{DD} = 10\text{ V}$  to  $16.5\text{ V}$ ,  $V_{SS} = -10\text{ V}$  to  $-16.5\text{ V}$ ; For  $\pm 2 \times V_{REF}$  range:  $V_{DD} = 5\text{ V}$  to  $16.5\text{ V}$ ,  $V_{SS} = -5\text{ V}$  to  $-16.5\text{ V}$ ;  
 $f_{SAMPLE} = 250\text{ kSPS}$ ,  $T_A = T_{MIN}$  to  $T_{MAX}$ , unless otherwise noted.<sup>1</sup>

**Table 3.**

Parameter	B Version <sup>1</sup>	Y Version <sup>1</sup>	Unit	Test Conditions/Comments
<b>DYNAMIC PERFORMANCE</b>				
Signal-to-Noise + Distortion (SINAD) <sup>2</sup>	73	73	dB min	$f_{IN} = 50\text{ kHz}$ sine wave
	73.5	73.5	dB typ	
Total Harmonic Distortion (THD) <sup>2</sup>	-88	-88	dB max	
	-92	-92	dB typ	
Peak Harmonic or Spurious Noise (SFDR) <sup>2</sup>	-97	-97	dB typ	
Intermodulation Distortion (IMD) <sup>2</sup>				$f_a = 50\text{ kHz}$ , $f_b = 49\text{ kHz}$
Second-Order Terms	-106	-106	dB typ	
Third-Order Terms	-101	-101	dB typ	
Aperture Delay	10	10	ns max	
Aperture Delay Matching	4	4	ns max	
Aperture Jitter	35	35	ps typ	
Channel-to-Channel Isolation <sup>2</sup>	-100	-100	dB typ	$f_{IN}$ on unselected channels up to $100\text{ kHz}$
Full Power Bandwidth	12	12	MHz typ	@ -3 dB
	2	2	MHz typ	@ -0.1 dB
<b>DC ACCURACY</b>				
Resolution	12	12	Bits	
No Missing Codes	12	12	Bits min	
Differential Nonlinearity	$\pm 0.7$	$\pm 0.7$	LSB max	
Integral Nonlinearity <sup>2</sup>	$\pm 1$	$\pm 1$	LSB max	
Positive Full-Scale Error <sup>2</sup>	$\pm 0.6104$	$\pm 0.6104$	% FS max	$\pm 0.244\%$ FSR typical
Positive Full-Scale Error Matching <sup>2</sup>	$\pm 0.366$	$\pm 0.366$	% FS max	
Bipolar Zero-Scale Error <sup>2</sup>	$\pm 3$	$\pm 3$	LSB max	$\pm 0.0488\%$ FSR typical
Bipolar Zero-Scale Error Matching <sup>2</sup>	$\pm 3$	$\pm 3$	LSB max	
Negative Full-Scale Error <sup>2</sup>	$\pm 0.6104$	$\pm 0.6104$	% FS max	$\pm 0.244\%$ FSR typical
Negative Full-Scale Error Matching <sup>2</sup>	$\pm 0.366$	$\pm 0.366$	% FS max	
<b>ANALOG INPUT</b>				
Input Voltage Ranges	$\pm 4 \times V_{REF}$	$\pm 4 \times V_{REF}$	V	See Table 8 for min $V_{DD}/V_{SS}$ for each range
	$\pm 2 \times V_{REF}$	$\pm 2 \times V_{REF}$	V	RNG bit/RANGE pin = 0
DC Leakage Current	$\pm 1$	$\pm 1$	$\mu\text{A}$ max	RNG bit/RANGE pin = 1
Input Capacitance <sup>3</sup>	10	10	pF typ	$\pm 4 \times V_{REF}$ range when in track
	14	14	pF typ	$\pm 2 \times V_{REF}$ range when in track
<b>REFERENCE INPUT/OUTPUT</b>				
Reference Input Voltage Range	2.5	2.5	V min/max	
DC Leakage Current	$\pm 1$	$\pm 1$	$\mu\text{A}$ max	
Input Capacitance <sup>3</sup>	18.5	18.5	pF typ	$\overline{\text{REF}}_{EN/DIS} = 1$
Reference Output Voltage	2.49/2.51	2.49/2.51	V min/max	
Long-Term Stability	150	150	ppm typ	1,000 hours
Reference Temperature Coefficient	25	25	ppm/ $^{\circ}\text{C}$ max	
	6	6	ppm/ $^{\circ}\text{C}$ typ	
<b>LOGIC INPUTS</b>				
Input High Voltage ( $V_{INH}$ )	$0.7 \times V_{DRIVE}$	$0.7 \times V_{DRIVE}$	V min	
Input Low Voltage ( $V_{INL}$ )	$0.3 \times V_{DRIVE}$	$0.3 \times V_{DRIVE}$	V max	
Input Current ( $I_{IN}$ )	$\pm 1$	$\pm 1$	$\mu\text{A}$ max	Typically $10\text{ nA}$ , $V_{IN} = 0\text{ V}$ or $V_{DRIVE}$
Input Capacitance ( $C_{IN}$ ) <sup>3</sup>	10	10	pF max	

Parameter	B Version <sup>1</sup>	Y Version <sup>1</sup>	Unit	Test Conditions/Comments
<b>LOGIC OUTPUTS</b>				
Output High Voltage ( $V_{OH}$ )	$V_{DRIVE} - 0.2$	$V_{DRIVE} - 0.2$	V min	$I_{SOURCE} = 200 \mu A$ $I_{SINK} = 200 \mu A$
Output Low Voltage ( $V_{OL}$ )	0.2	0.2	V max	
Floating-State Leakage Current	$\pm 1$	$\pm 1$	$\mu A$ max	
Floating-State Output Capacitance <sup>3</sup>	10	10	pF max	
Output Coding	Twos complement			
<b>CONVERSION RATE</b>				
Conversion Time	3.1	3.1	$\mu s$ max	Parallel interface mode only
Track-and-Hold Acquisition Time <sup>2,3</sup>	550	550	ns max	
Throughput Rate	250	250	kSPS	
<b>POWER REQUIREMENTS</b>				
$V_{DD}$	5/15	5/15	V nom min/max	For 4 x $V_{REF}$ range, $V_{DD} = 10 V$ to 16.5 V For 4 x $V_{REF}$ range, $V_{DD} = -10 V$ to -16.5 V
$V_{SS}$	-5/-15	-5/-15	V nom min/max	
$AV_{CC}$	5	5	V nom	Digital I/Ps = 0 V or $V_{DRIVE}$ $AV_{CC} = DV_{CC} = V_{DRIVE} = 5.25 V$ , $V_{DD} = 16.5 V$ , $V_{SS} = -16.5 V$ $f_{SAMPLE} = 250$ kSPS, $AV_{CC} = DV_{CC} = V_{DRIVE} = 5.25 V$ , $V_{DD} = 16.5 V$ , $V_{SS} = -16.5 V$ $V_{SS} = -16.5 V$ , $f_{SAMPLE} = 250$ kSPS $V_{DD} = 16.5 V$ , $f_{SAMPLE} = 250$ kSPS $AV_{CC} = DV_{CC} = V_{DRIVE} = 5.25 V$ , $V_{DD} = 16.5 V$ , $V_{SS} = -16.5 V$ SCLK on or off, $AV_{CC} = DV_{CC} = V_{DRIVE} = 5.25 V$ , $V_{DD} = 16.5 V$ , $V_{SS} = -16.5 V$ $AV_{CC} = DV_{CC} = V_{DRIVE} = 5.25 V$ , $V_{DD} = 16.5 V$ , $V_{SS} = -16.5 V$  $f_{SAMPLE} = 250$ kSPS
$DV_{CC}$	5	5	V nom	
$V_{DRIVE}$	3/5	3/5	V nom min/max	
$I_{TOTAL}$				
Normal Mode (Static) (Includes $I_{AV_{CC}}$ , $I_{V_{DD}}$ , $I_{V_{SS}}$ , $I_{V_{DRIVE}}$ , $I_{DV_{CC}}$ )	28	28	mA max	
Normal Mode (Operational) (Includes $I_{AV_{CC}}$ , $I_{V_{DD}}$ , $I_{V_{SS}}$ , $I_{V_{DRIVE}}$ , $I_{DV_{CC}}$ )	TBD	TBD	mA max	
$I_{SS}$ (Operational)	0.25	0.25	mA max	
$I_{DD}$ (Operational)	0.25	0.25	mA max	
Partial Power-Down Mode	7	7	mA max	
Full Power-Down Mode ( $\overline{STBY}$ Pin)	80	80	$\mu A$ max	
Power Dissipation				
Normal Mode (Static)	143	143	mW max	
Normal Mode (Operational)	TBD	TBD	mW max	
Partial Power-Down Mode	35	35	mW max	
Full Power-Down Mode ( $\overline{STBY}$ Pin)	100	100	$\mu W$ max	

<sup>1</sup> Temperature ranges are as follows: B version is -40°C to +85°C, Y version is -40°C to +125°C

<sup>2</sup> See the Terminology section.

<sup>3</sup> Sample tested during initial release to ensure compliance.



**TIMING SPECIFICATIONS**

$AV_{CC}/DV_{CC} = 4.75\text{ V to }5.25\text{ V}$ ,  $V_{DD} = 5\text{ V to }16.5\text{ V}$ ,  $V_{SS} = -5\text{ V to }-16.5\text{ V}$ ,  $V_{DRIVE} = 2.7\text{ V to }5.25\text{ V}$ ,  $V_{REF} = 2.5\text{ V internal/external}$ ,  $T_A = T_{MIN}\text{ to }T_{MAX}$ , unless otherwise noted.<sup>1</sup>

**Table 4.**

Parameter	Limit at $T_{MIN}, T_{MAX}$		Unit	Description
	$V_{DRIVE} < 4.75\text{ V}$	$V_{DRIVE} = 4.75\text{ V to }5.25\text{ V}$		
<b>PARALLEL MODE</b>				
$t_{CONVERT}$	3	3	$\mu\text{s typ}$	Conversion time, internal clock
$t_{QUIET}$	150	150	ns min	Minimum quiet time required between bus relinquish and start of next conversion
$t_{ACQ}$	550	550	ns min	Acquisition time
$t_{10}$	25	25	ns min	Minimum CONVST low pulse
$t_1$	60	60	ns min	CONVST high to BUSY high
$t_{WAKE-UP}$	2	2	ms max	$\overline{STBY}$ rising edge to CONVST rising edge
	25	25	$\mu\text{s max}$	Partial power-down mode
<b>PARALLEL WRITE OPERATION</b>				
$t_{11}$	15	15	ns min	$\overline{WR}$ pulse width
$t_{12}$	0	0	ns min	$\overline{CS}$ to $\overline{WR}$ setup time
$t_{13}$	5	5	ns min	$\overline{CS}$ to $\overline{WR}$ hold time
$t_{14}$	5	5	ns min	Data setup time before $\overline{WR}$ rising edge
$t_{15}$	5	5	ns min	Data hold after $\overline{WR}$ rising edge
<b>PARALLEL READ OPERATION</b>				
$t_2$	0	0	ns min	BUSY to $\overline{RD}$ delay
$t_3$	0	0	ns min	$\overline{CS}$ to $\overline{RD}$ setup time
$t_4$	0	0	ns min	$\overline{CS}$ to $\overline{RD}$ hold time
$t_5$	45	36	ns min	$\overline{RD}$ pulse width
$t_6$	45	36	ns max	Data access time after $\overline{RD}$ falling edge
$t_7$	10	10	ns min	Data hold time after $\overline{RD}$ rising edge
$t_8$	12	12	ns max	Bus relinquish time after $\overline{RD}$ rising edge
$t_9$	6	6	ns min	Minimum time between reads
<b>SERIAL INTERFACE</b>				
$f_{SCLK}$	18	18	MHz max	Frequency of serial read clock
$t_{16}$	12	12	ns max	Delay from $\overline{CS}$ until SDATA three-state disabled
$t_{17}^2$	22	22	ns max	Data access time after SCLK rising edge/ $\overline{CS}$ falling edge
$t_{18}$	$0.4 t_{SCLK}$	$0.4 t_{SCLK}$	ns min	SCLK low pulse width
$t_{19}$	$0.4 t_{SCLK}$	$0.4 t_{SCLK}$	ns min	SCLK high pulse width
$t_{20}$	10	10	ns min	SCLK to data valid hold time after SCLK falling edge
$t_{21}$	18	18	ns max	$\overline{CS}$ rising edge to SDATA high impedance

<sup>1</sup> Sample tested during initial release to ensure compliance. All input signals are specified with  $t_r = t_f = 5\text{ ns}$  (10% to 90% of  $V_{DD}$ ) and timed from a voltage level of 1.6 V.

<sup>2</sup> A buffer is used on the data output pins for this measurement.

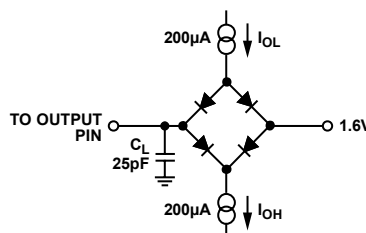

Figure 2. Load Circuit for Digital Output Timing Specification

## ABSOLUTE MAXIMUM RATINGS

$T_A = 25^\circ\text{C}$ , unless otherwise noted.

**Table 5.**

Parameter	Rating
$V_{DD}$ to AGND, DGND	-0.3 V to +16.5 V
$V_{SS}$ to AGND, DGND	+0.3 V to -16.5 V
$V_{DD}$ to $AV_{CC}$	$V_{CC} - 0.3$ V to 16.5 V
$AV_{CC}$ to AGND, DGND	-0.3 V to +7 V
$DV_{CC}$ to $AV_{CC}$	-0.3 V to $AV_{CC} + 0.3$ V
$DV_{CC}$ to DGND, AGND	-0.3 V to +7 V
AGND to DGND	-0.3 V to +0.3 V
$V_{DRIVE}$ to DGND	-0.3 V to $DV_{CC} + 0.3$ V
Analog Input Voltage to AGND <sup>1</sup>	$V_{SS} - 0.3$ V to $V_{DD} + 0.3$ V
Digital Input Voltage to DGND	-0.3 V to $V_{DRIVE} + 0.3$ V
Digital Output Voltage to GND	-0.3 V to $V_{DRIVE} + 0.3$ V
REFIN to AGND	-0.3 V to $AV_{CC} + 0.3$ V
Input Current to Any Pin Except Supplies <sup>2</sup>	$\pm 10$ mA
Operating Temperature Range	
B Version	-40°C to +85°C
Y Version	-40°C to +125°C
Storage Temperature Range	-65°C to +150°C
Junction Temperature	150°C
Pb/SN Temperature, Soldering	
Reflow (10 sec to 30 sec)	240(+0)°C
Pb-Free Temperature, Soldering Reflow	260(+0)°C

<sup>1</sup> If the analog inputs are being driven from alternative  $V_{DD}$  and  $V_{SS}$  supply circuitry, a 240  $\Omega$  series resistor should be placed on the analog inputs.

<sup>2</sup> Transient currents of up to 100 mA do not cause SCR latch-up.

Stresses above those listed under Absolute Maximum Ratings may cause permanent damage to the device. This is a stress rating only; functional operation of the device at these or any other conditions above those indicated in the operational section of this specification is not implied. Exposure to absolute maximum rating conditions for extended periods may affect device reliability.

## THERMAL RESISTANCE

$\theta_{JA}$  is specified for the worst-case conditions, that is, a device soldered in a circuit board for surface-mount packages. These specifications apply to a four-layer board.

**Table 6. Thermal Resistance**

Package Type	$\theta_{JA}$	$\theta_{JC}$	Unit
64-Lead LQFP	45	11	°C/W

## ESD CAUTION

ESD (electrostatic discharge) sensitive device. Electrostatic charges as high as 4000 V readily accumulate on the human body and test equipment and can discharge without detection. Although this product features proprietary ESD protection circuitry, permanent damage may occur on devices subjected to high energy electrostatic discharges. Therefore, proper ESD precautions are recommended to avoid performance degradation or loss of functionality.



## PIN CONFIGURATION AND FUNCTION DESCRIPTIONS

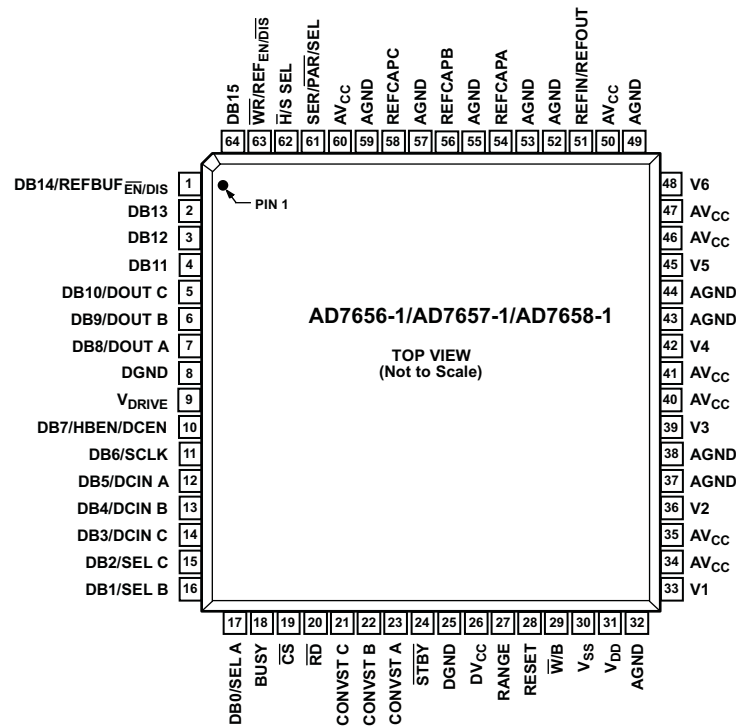

Figure 3. Pin Configuration

Table 7. Pin Function Descriptions

Pin No.	Mnemonic	Description
54, 56, 58	REFCAPA, REFCAPB, REFCAPC	Decoupling capacitors are connected to these pins. This decouples the reference buffer for each ADC pair. Each REFCAP pin should be decoupled to AGND using a 1 $\mu$ F.
33, 36, 39, 42, 45, 48	V1 to V6	Analog Input 1 to 6. These are six single-ended analog inputs. In hardware mode, the analog input range on these channels is determined by the RANGE pin. In software mode, it is determined by bits RNGC to RNGA of the control register (see Table 10).
32, 37, 38, 43, 44, 49, 52, 53, 55, 57, 59	AGND	Analog Ground. Ground reference point for all analog circuitry on the AD7656-1/AD7657-1/AD7658-1. All analog input signals and any external reference signal should be referred to this AGND voltage. All 11 of these AGND pins should be connected to the AGND plane of a system. The AGND and DGND voltages should ideally be at the same potential and must not be more than 0.3 V apart, even on a transient basis.
26	DV <sub>CC</sub>	Digital Power, 4.75 V to 5.25 V. The DV <sub>CC</sub> and AV <sub>CC</sub> voltages should ideally be at the same potential and must not be more than 0.3 V apart, even on a transient basis. This supply should be decoupled to DGND, and 10 $\mu$ F and 100 nF decoupling capacitors should be placed on the DV <sub>CC</sub> pin.
9	V <sub>DRIVE</sub>	Logic Power Supply Input. The voltage supplied at this pin determines the operating voltage of the interface. Nominally at the same supply as the supply of the host interface.
8, 25	DGND	Digital Ground. This is the ground reference point for all digital circuitry on the AD7656-1/AD7657-1/AD7658-1. Both DGND pins should connect to the DGND plane of a system. The DGND and AGND voltages should ideally be at the same potential and must not be more than 0.3 V apart, even on a transient basis.
34, 35, 40, 41, 46, 47, 50, 60	AV <sub>CC</sub>	Analog Supply Voltage, 4.75 V to 5.25 V. This is the supply voltage for the ADC cores. The AV <sub>CC</sub> and DV <sub>CC</sub> voltages should ideally be at the same potential and must not be more than 0.3 V apart, even on a transient basis.
23, 22, 21	CONVST A, CONVST B, CONVST C	Conversion Start Input A, B, C. These logic inputs are used to initiate conversions on the ADC pairs. CONVST A is used to initiate simultaneous conversions on V1 and V2. CONVST B is used to initiate simultaneous conversions on V3 and V4. CONVST C is used to initiate simultaneous conversions on V5 and V6. When CONVSTx switches from low to high, the track-and-hold switch on the selected ADC pair switches from track to hold and the conversion is initiated. These inputs can also be used to place the ADC pairs into partial power-down mode.

Pin No.	Mnemonic	Description
19	$\overline{\text{CS}}$	Chip Select. This active low logic input frames the data transfer. When both $\overline{\text{CS}}$ and $\overline{\text{RD}}$ are logic low in parallel mode, the output bus is enabled and the conversion result is output on the parallel data bus lines. When both $\overline{\text{CS}}$ and $\overline{\text{WR}}$ are logic low in parallel mode, DB[15:8] are used to write data to the on-chip control register. In serial mode, the $\overline{\text{CS}}$ is used to frame the serial read transfer and clock out the MSB of the serial output data.
20	$\overline{\text{RD}}$	Read Data. When both $\overline{\text{CS}}$ and $\overline{\text{RD}}$ are logic low in parallel mode, the output bus is enabled. In serial mode, the $\overline{\text{RD}}$ line should be held low.
63	$\overline{\text{WR}}/\overline{\text{REFEN/DIS}}$	Write Data/Reference Enable/Disable. When $\overline{\text{H/S SEL}}$ pin is high and both $\overline{\text{CS}}$ and $\overline{\text{WR}}$ are logic low, DB[15:8] are used to write data to the internal control register. When the $\overline{\text{H/S SEL}}$ pin is low, this pin is used to enable or disable the internal reference. When $\overline{\text{H/S SEL}} = 0$ and $\overline{\text{REF EN/DIS}} = 0$ , the internal reference is disabled and an external reference should be applied to the REFIN/REFOUT pin. When $\overline{\text{H/S SEL}} = 0$ and $\overline{\text{REF EN/DIS}} = 1$ , the internal reference is enabled and the REFIN/REFOUT pin should be decoupled. See the Reference Section.
18	BUSY	BUSY Output. This pin transitions high when a conversion is started and remains high until the conversion is complete and the conversion data is latched into the output data registers. A new conversion should not be initiated on the AD7656-1/AD7657-1/AD7658-1 when the BUSY signal is high.
51	REFIN/REFOUT	Reference Input/Output. The on-chip reference is available on this pin for use external to the AD7656-1/AD7657-1/AD7658-1. Alternatively, the internal reference can be disabled and an external reference can be applied to this input. See the Reference Section. When the internal reference is enabled, this pin should be decoupled using at least a 10 $\mu\text{F}$ decoupling cap.
61	$\overline{\text{SER/PAR}}/\overline{\text{SEL}}$	Serial/Parallel Selection Input. When this pin is low, the parallel interface is selected. When this pin is high, the serial interface mode is selected. In serial mode, DB[10:8] take on their DOUT[C:A] function, DB[0:2] take on their DOUT select function, DB7 takes on its DCEN function. In serial mode, DB15 and DB[13:11] should be tied to DGND.
17	DB0/SEL A	Data Bit 0/Select DOUT A. When $\overline{\text{SER/PAR}} = 0$ , this pin acts as a three-state parallel digital output pin. When $\overline{\text{SER/PAR}} = 1$ , this pin takes on its SEL A function; it is used to configure the serial interface. If this pin is 1, the serial interface operates with one/two/three DOUT output pins and enables DOUT A as a serial output. When operating in serial mode, this pin should always be = 1.
16	DB1/SEL B	Data Bit 1/Select DOUT B. When $\overline{\text{SER/PAR}} = 0$ , this pin acts as a three-state parallel digital output pin. When $\overline{\text{SER/PAR}} = 1$ , this pin takes on its SEL B function; it is used to configure the serial interface. If this pin is 1, the serial interface operates with two/three DOUT output pins and enables DOUT B as a serial output. If this pin is 0, the DOUT B is not enabled to operate as a serial data output pin and only one DOUT output pin, DOUT A, is used. Unused serial DOUT pins should be left unconnected.
15	DB2/SEL C	Data Bit 2/Select DOUT C. When $\overline{\text{SER/PAR}} = 0$ , this pin acts as a three-state parallel digital output pin. When $\overline{\text{SER/PAR}} = 1$ , this pin takes on its SEL C function; it is used to configure the serial interface. If this pin is 1, the serial interface operates with three DOUT output pins and enables DOUT C as a serial output. If this pin is 0, the DOUT C is not enabled to operate as a serial data output pin. Unused serial DOUT pins should be left unconnected.
14	DB3/DCIN C	Data Bit 3/Daisy-Chain Input C. When $\overline{\text{SER/PAR}} = 0$ , this pin acts as a three-state parallel digital output pin. When $\overline{\text{SER/PAR}} = 1$ and $\text{DCEN} = 1$ , this pin acts as Daisy-Chain Input C. When operating in serial mode but not in daisy-chain mode, this pin should be tied to DGND.
13	DB4/DCIN B	Data Bit 4/Daisy-Chain Input B. When $\overline{\text{SER/PAR}} = 0$ , this pin acts as a three-state parallel digital output pin. When $\overline{\text{SER/PAR}} = 1$ and $\text{DCEN} = 1$ , this pin acts as Daisy-Chain Input B. When operating in serial mode but not in daisy-chain mode, this pin should be tied to DGND.
12	DB5/DCIN A	Data Bit 5/Daisy-Chain Input A. When $\overline{\text{SER/PAR}}$ is low, this pin acts as a three-state parallel digital output pin. When $\overline{\text{SER/PAR}} = 1$ and $\text{DCEN} = 1$ , this pin acts as Daisy-Chain Input A. When operating in serial mode but not in daisy-chain mode, this pin should be tied to DGND.
11	DB6/SCLK	Data Bit 6/Serial Clock. When $\overline{\text{SER/PAR}} = 0$ , this pin acts as a three-state parallel digital output pin. When $\overline{\text{SER/PAR}} = 1$ , this pin takes on its SCLK input function; it is the read serial clock for the serial transfer.
10	DB7/HBEN/DCEN	Data Bit 7/High Byte Enable/Daisy-Chain Enable. When operating in parallel word mode ( $\overline{\text{SER/PAR}} = 0$ and $\overline{\text{W/B}} = 0$ ), this pin takes on its Data Bit 7 function. When operating in parallel byte mode ( $\overline{\text{SER/PAR}} = 0$ and $\overline{\text{W/B}} = 1$ ), this pin takes on its HBEN function. When in this mode and the HBEN pin is logic high, the data is output MSB byte first on DB[15:8]. When the HBEN pin is logic low, the data is output LSB byte first on DB[15:8]. When operating in serial mode ( $\overline{\text{SER/PAR}} = 1$ ), this pin takes on its DCEN function. When the DCEN pin is logic high, the parts operate in daisy-chain mode with DB[5:3] taking on their DCIN[A:C] function. When operating in serial mode but not in daisy-chain mode, this pin should be tied to DGND.

Pin No.	Mnemonic	Description
7	DB8/DOUT A	Data Bit 8/Serial Data Output A. When $\overline{\text{SER/}\overline{\text{PAR}}} = 0$ , this pin acts as a three-state parallel digital output pin. When $\overline{\text{SER/}\overline{\text{PAR}}} = 1$ and $\text{SEL A} = 1$ , this pin takes on its DOUT A function and outputs serial conversion data.
6	DB9/DOUT B	Data Bit 9/Serial Data Output B. When $\overline{\text{SER/}\overline{\text{PAR}}} = 0$ , this pin acts as a three-state parallel digital output pin. When $\overline{\text{SER/}\overline{\text{PAR}}} = 1$ and $\text{SEL B} = 1$ , this pin takes on its DOUT B function and outputs serial conversion data. This configures the serial interface to have two DOUT output lines.
5	DB10/DOUT C	Data Bit 10/Serial Data Output C. When $\overline{\text{SER/}\overline{\text{PAR}}} = 0$ , this pin acts as a three-state parallel digital output pin. When $\overline{\text{SER/}\overline{\text{PAR}}} = 1$ and $\text{SEL C} = 1$ , this pin takes on its DOUT C function and outputs serial conversion data. This configures the serial interface to have three DOUT output lines.
4	DB11	Data Bit 11/Digital Ground. When $\overline{\text{SER/}\overline{\text{PAR}}} = 0$ , this pin acts as a three-state parallel digital output pin. When $\overline{\text{SER/}\overline{\text{PAR}}} = 1$ , this pin should be tied to DGND.
3, 2, 64	DB12, DB13, DB15	Data Bit 12, 13, 15. When $\overline{\text{SER/}\overline{\text{PAR}}} = 0$ , these pins act as three-state parallel digital input/output pins. When $\overline{\text{CS}}$ and $\overline{\text{RD}}$ are low, these pins are used to output the conversion result. When $\overline{\text{CS}}$ and $\overline{\text{WR}}$ are low, these pins are used to write to the control register. When $\overline{\text{SER/}\overline{\text{PAR}}} = 1$ , these pins should be tied to DGND. For the AD7657, DB15 contains a leading zero. For the AD7658, DB15, DB13, and DB12 contain leading zeros.
1	DB14/REFBUF $\overline{\text{EN/}\overline{\text{DIS}}}$	Data Bit 14/REFBUF Enable/Disable. When $\overline{\text{SER/}\overline{\text{PAR}}} = 0$ , this pin acts as a three-state digital input/output pin. For the AD7657/AD7658, DB14 contains a leading zero. When $\overline{\text{SER/}\overline{\text{PAR}}} = 1$ , this pin can be used to enable or disable the internal reference buffers.
28	RESET	Reset Input. When set to logic high, this pin resets the AD7656-1/AD7657-1/AD7658-1. The current conversion, if any, is aborted. The internal register is set to all 0s. In hardware mode, the AD7656-1/AD7657-1/AD7658-1 are configured depending on the logic levels on the hardware select pins. In all modes, the parts should receive a RESET pulse after power-up. The reset high pulse should be typically 100 ns wide. After the RESET pulse, the AD7656-1/AD7657-1/AD7658-1 needs to see a valid CONVST pulse in order to initiate a conversion; this should consist of a high-to-low CONVST edge followed by a low-to-high CONVST edge. The CONVST signal should be high during the RESET pulse.
27	RANGE	Analog Input Range Selection. Logic input. The logic level on this pin determines the input range of the analog input channels. When this pin is Logic 1 at the falling edge of BUSY, the range for the next conversion is $\pm 2 \times V_{\text{REF}}$ . When this pin is Logic 0 at the falling edge of BUSY, the range for the next conversion is $\pm 4 \times V_{\text{REF}}$ . In hardware select mode, the RANGE pin is checked on the falling edge of BUSY. In software mode ( $\overline{\text{H/S SEL}} = 1$ ), the RANGE pin can be tied to DGND and the input range is determined by the RNGA, RNGB, and RNGC bits in the control register.
31	V <sub>DD</sub>	Positive Power Supply Voltage. This is the positive supply voltage for the analog input section.
30	V <sub>SS</sub>	Negative Power Supply Voltage. This is the negative supply voltage for the analog input section.
24	STBY	Standby Mode Input. This pin is used to put all six on-chip ADCs into standby mode. The STBY pin is high for normal operation and low for standby operation.
62	H/S SEL	Hardware/Software Select Input. Logic input. When $\overline{\text{H/S SEL}} = 0$ , the AD7656-1/AD7657-1/AD7658-1 operate in hardware select mode, and the ADC pairs to be simultaneously sampled are selected by the $\overline{\text{CONVST}}$ pins. When $\overline{\text{H/S SEL}} = 1$ , the ADC pairs to be sampled simultaneously are selected by writing to the control register. In serial mode, CONVST A is used to initiate conversions on the selected ADC pairs.
29	W/B	Word/Byte Input. When this pin is logic low, data can be transferred to and from the AD7656-1/AD7657-1/AD7658-1 using the parallel data lines DB[15:0]. When this pin is logic high, byte mode is enabled. In this mode, data is transferred using data lines DB[15:8] and DB[7] takes on its HBEN function. To obtain the 16-bit conversion result, 2-byte reads are required. In serial mode, this pin should be tied to DGND.

TYPICAL PERFORMANCE CHARACTERISTICS

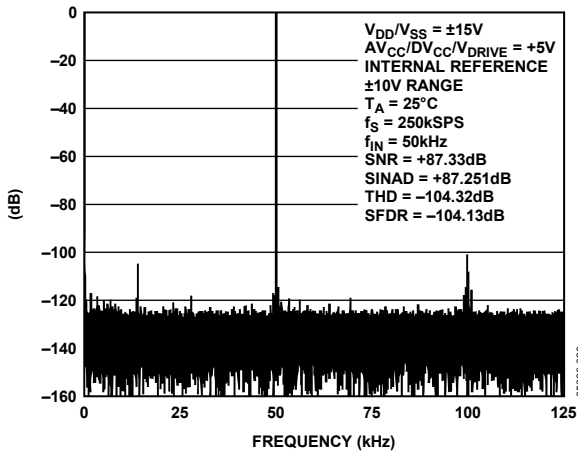

Figure 4. AD7656-1 FFT for ±10 V Range

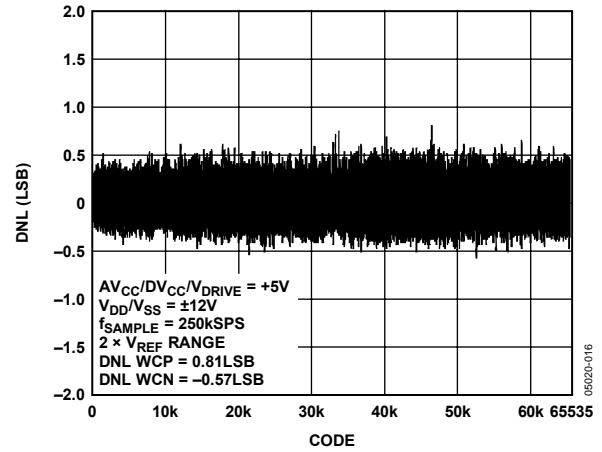

Figure 7. AD7656-1 Typical DNL

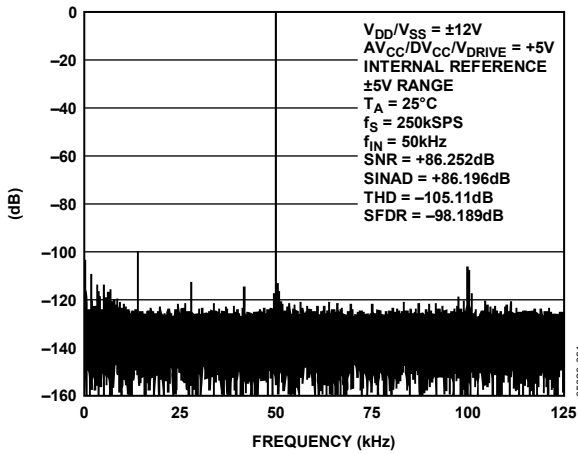

Figure 5. AD7656-1 FFT for ±5 V Range

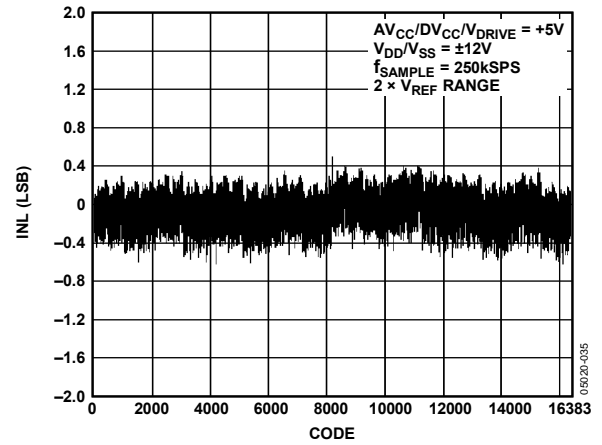

Figure 8. AD7657-1 Typical INL

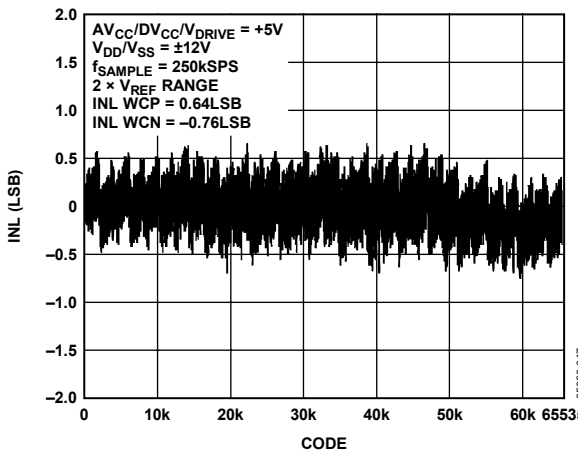

Figure 6. AD7656-1 Typical INL

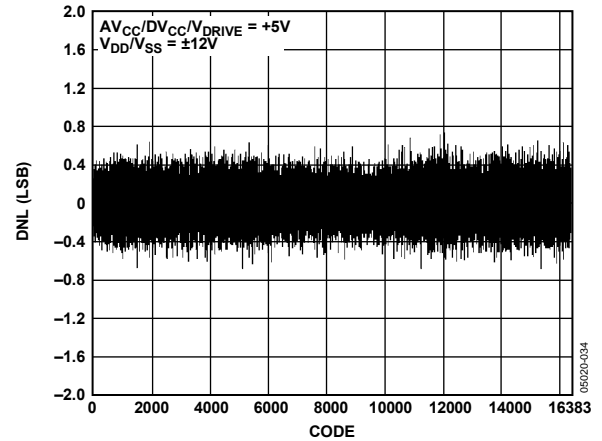

Figure 9. AD7657-1 Typical DNL

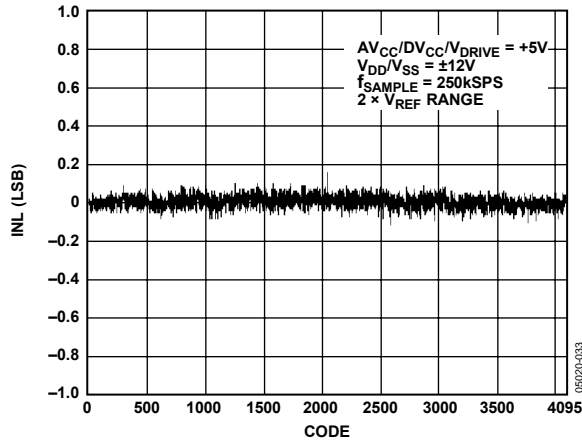

Figure 10. AD7658 Typical INL

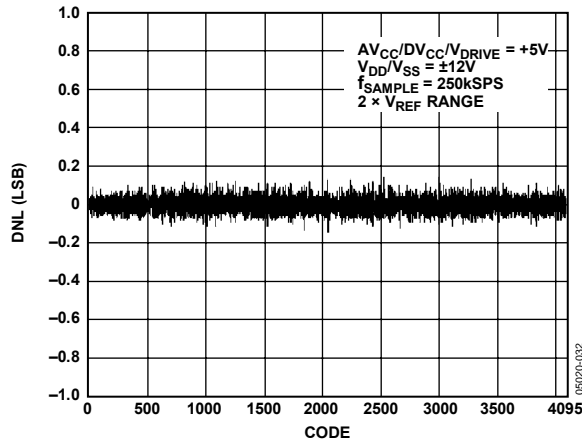

Figure 11. AD7658 Typical DNL

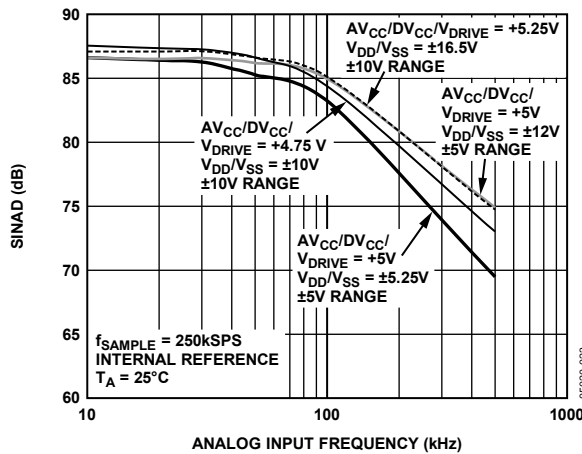

Figure 12. AD7656-1 SINAD vs. Input Frequency

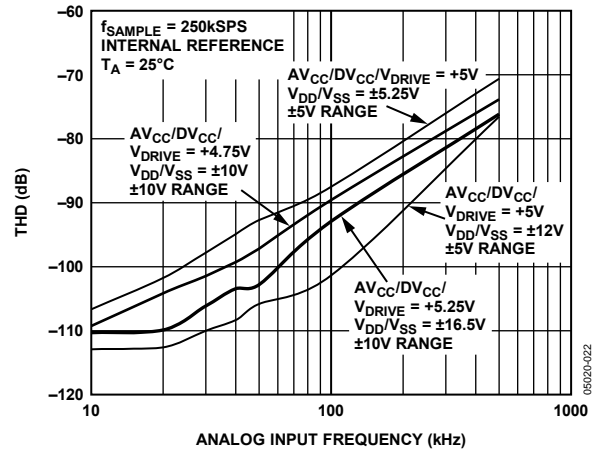

Figure 13. AD7656 THD vs. Input Frequency

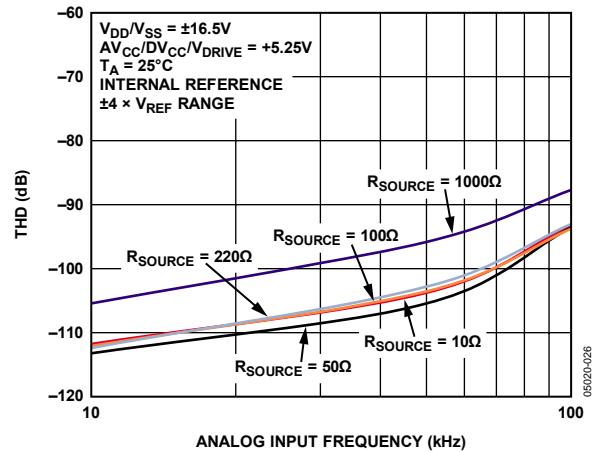

Figure 14. AD7656 THD vs. Input Frequency for Various Source Impedances,  $\pm 4 \times V_{REF}$  Range

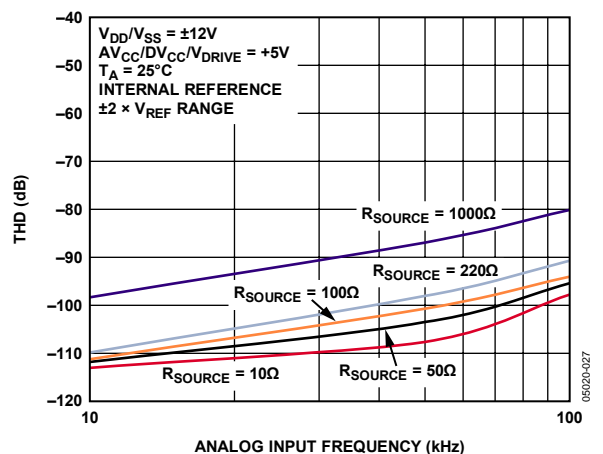

Figure 15. AD7656-1 THD vs. Input Frequency for Various Source Impedances,  $\pm 2 \times V_{REF}$  Range

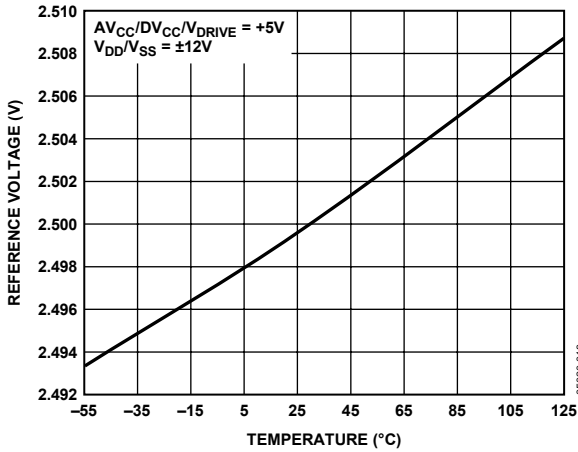

Figure 16. Reference Voltage vs. Temperature

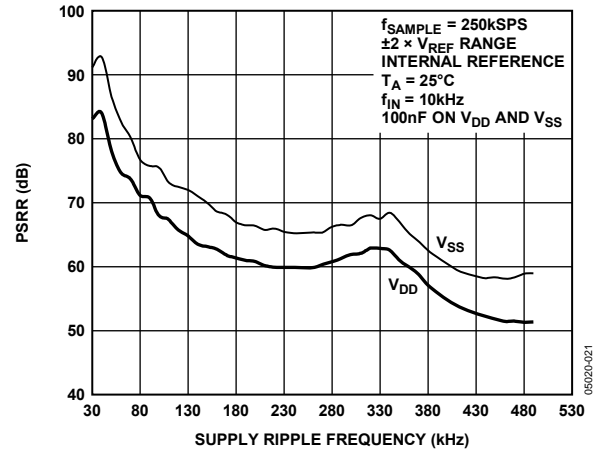

Figure 19. PSRR vs. Supply Ripple Frequency

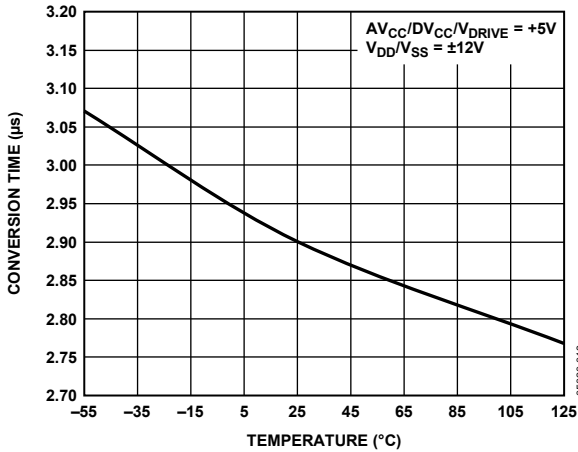

Figure 17. Conversion Time vs. Temperature

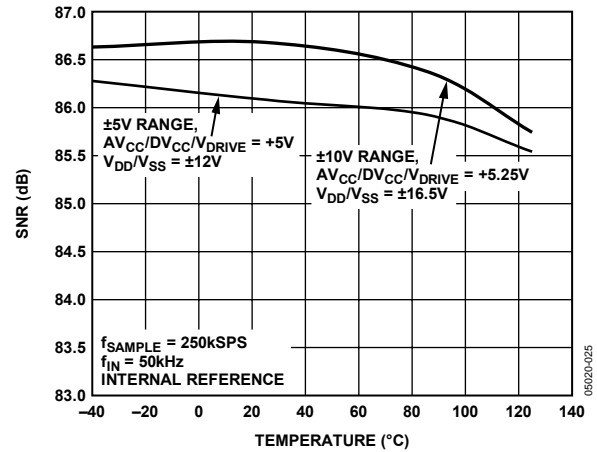

Figure 20. AD7656 SNR vs. Temperature

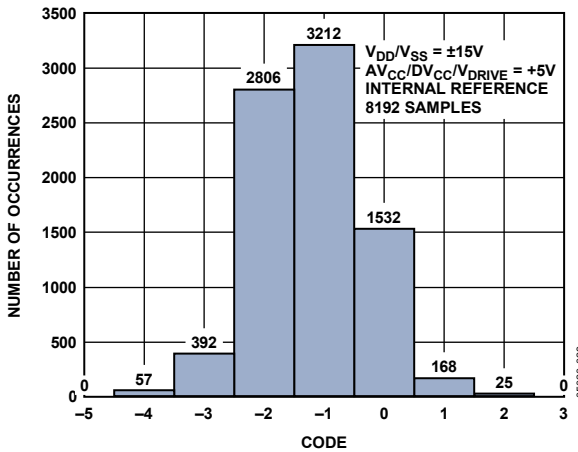

Figure 18. AD7656 Histogram of Codes

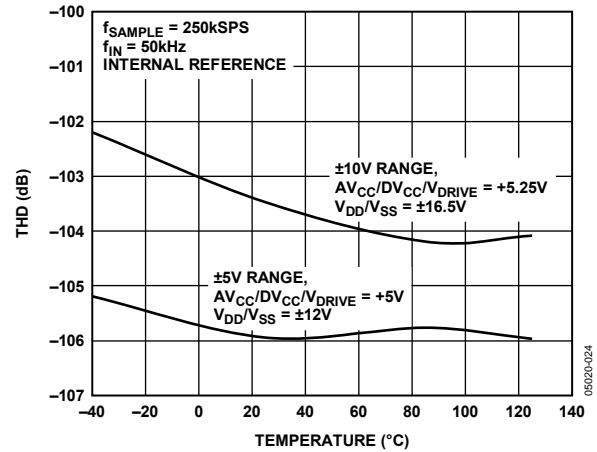

Figure 21. AD7656-1 THD vs. Temperature



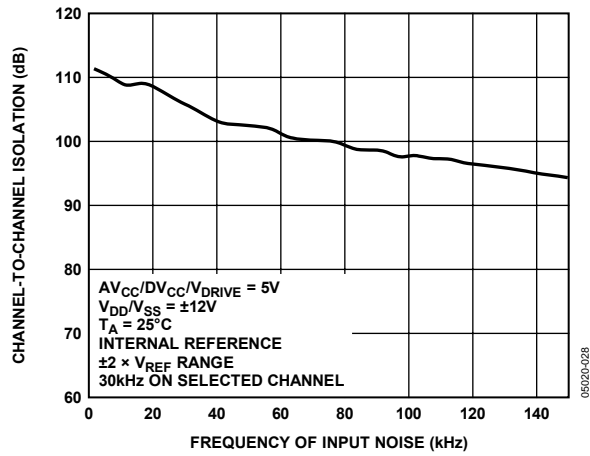

Figure 22. Channel-to-Channel Isolation

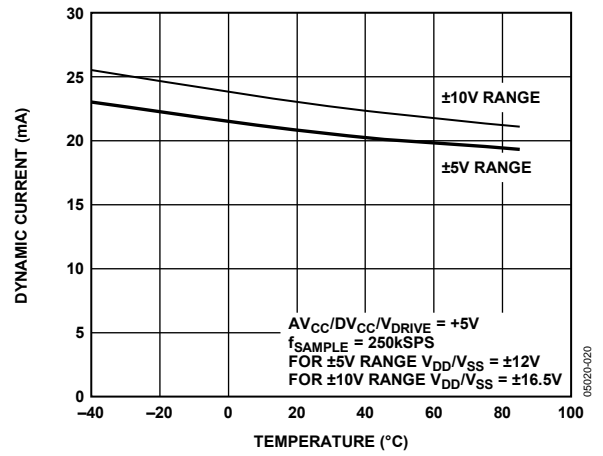

Figure 23. Dynamic Current vs. Temperature

## TERMINOLOGY

### Integral Nonlinearity

The maximum deviation from a straight line passing through the endpoints of the ADC transfer function. The endpoints of the transfer function are zero scale, a ½ LSB below the first code transition and full scale at ½ LSB above the last code transition.

### Differential Nonlinearity

The difference between the measured and the ideal 1 LSB change between any two adjacent codes in the ADC.

### Bipolar Zero Code Error

The deviation of the midscale transition (all 1s to all 0s) from the ideal  $V_{IN}$  voltage, that is, AGND – 1 LSB.

### Bipolar Zero Code Error Match

The difference in bipolar zero code error between any two input channels.

### Positive Full-Scale Error

The deviation of the last code transition (011...110) to (011...111) from the ideal ( $+4 \times V_{REF} - 1$  LSB,  $+2 \times V_{REF} - 1$  LSB) after adjusting for the bipolar zero code error.

### Positive Full-Scale Error Match

The difference in positive full-scale error between any two input channels.

### Negative Full-Scale Error

The deviation of the first code transition (10...000) to (10...001) from the ideal ( $-4 \times V_{REF} + 1$  LSB,  $-2 \times V_{REF} + 1$  LSB) after adjusting for the bipolar zero code error.

### Negative Full-Scale Error Match

The difference in negative full-scale error between any two input channels.

### Track-and-Hold Acquisition Time

The track-and-hold amplifier returns to track mode at the end of the conversion. The track-and-hold acquisition time is the time required for the output of the track-and-hold amplifier to reach its final value, within  $\pm 1$  LSB, after the end of the conversion. See the Track-and-Hold Section for more details.

### Signal-to-(Noise + Distortion) Ratio

The measured ratio of signal-to-(noise + distortion) at the output of the ADC. The signal is the rms amplitude of the fundamental. Noise is the sum of all nonfundamental signals up to half the sampling frequency ( $f_s/2$ , excluding dc).

The ratio depends on the number of quantization levels in the digitization process: the more levels, the smaller the quantization noise. The theoretical signal-to-(noise + distortion) ratio for an ideal N-bit converter with a sine wave input is given by

$$\text{Signal-to-(Noise + Distortion)} = (6.02 N + 1.76) \text{ dB}$$

Thus, this is 98 dB for a 16-bit converter, 86.04 dB for a 14-bit converter, and 74 dB for a 12-bit converter.

### Total Harmonic Distortion (THD)

The ratio of the rms sum of the harmonics to the fundamental. For the AD7656-1/AD7657-1/AD7658-1, it is defined as

$$\text{THD(dB)} = 20 \log \frac{\sqrt{V_2^2 + V_3^2 + V_4^2 + V_5^2 + V_6^2}}{V_1}$$

where:

$V_1$  is the rms amplitude of the fundamental.

$V_2, V_3, V_4, V_5,$  and  $V_6$  are the rms amplitudes of the second through sixth harmonics.

### Peak Harmonic or Spurious Noise

The ratio of the rms value of the next largest component in the ADC output spectrum (up to  $f_s/2$ , excluding dc) to the rms value of the fundamental. Normally, the value of this specification is determined by the largest harmonic in the spectrum, but for ADCs where the harmonics are buried in the noise floor, it is determined by a noise peak.

### Intermodulation Distortion

With inputs consisting of sine waves at two frequencies,  $f_a$  and  $f_b$ , any active device with nonlinearities create distortion products at sum and difference frequencies of  $m f_a \pm n f_b$ , where  $m, n = 0, 1, 2, 3$ . Intermodulation distortion terms are those for which neither  $m$  nor  $n$  are equal to 0. For example, the second-order terms include  $(f_a + f_b)$  and  $(f_a - f_b)$ , and the third-order terms include  $(2f_a + f_b)$ ,  $(2f_a - f_b)$ ,  $(f_a + 2f_b)$ , and  $(f_a - 2f_b)$ .

The AD7656-1/AD7657-1/AD7658-1 are tested using the CCIF standard in which two input frequencies near the top end of the input bandwidth are used. In this case, the second-order terms are usually distanced in frequency from the original sine waves, and the third-order terms are usually at a frequency close to the input frequencies. As a result, the second- and third-order terms are specified separately. The calculation of the intermodulation distortion is per the THD specification, where it is the ratio of the rms sum of the individual distortion products to the rms amplitude of the sum of the fundamentals expressed in decibels.

**Power Supply Rejection (PSR)**

Variations in power supply affect the full-scale transition but not the converter's linearity. Power supply rejection is the maximum change in full-scale transition point due to a change in power supply voltage from the nominal value. See the Typical Performance Characteristics section.

Figure 19 shows the power supply rejection ratio vs. supply ripple frequency for the AD7656-1/AD7657-1/AD7658-1. The power supply rejection ratio is defined as the ratio of the power in the ADC output at full-scale frequency,  $f$ , to the power of a 200 mV p-p sine wave applied to the ADC's  $V_{DD}$  and  $V_{SS}$  supplies of frequency  $f_s$

$$PSRR \text{ (dB)} = 10 \log (P_f/P_{f_s})$$

where:

$P_f$  is equal to the power at frequency  $f$  in the ADC output.

$P_{f_s}$  is equal to the power at frequency  $f_s$  coupled onto the  $V_{DD}$  and  $V_{SS}$  supplies.

**Channel-to-Channel Isolation**

Channel-to-channel isolation is a measure of the level of crosstalk between any two channels. It is measured by applying a full-scale, 100 kHz sine wave signal to all unselected input channels and determining the degree to which the signal attenuates in the selected channel with a 30 kHz signal.

## THEORY OF OPERATION

### CONVERTER DETAILS

The AD7656-1/AD7657-1/AD7658-1 are high speed, low power converters that allow the simultaneous sampling of six on-chip ADCs. The analog inputs on the AD7656-1/AD7657-1/AD7658-1 can accept true bipolar input signals. The RANGE pin/RNG bits are used to select either  $\pm 4 \times V_{REF}$  or  $\pm 2 \times V_{REF}$  as the input range for the next conversion.

Each AD7656-1/AD7657-1/AD7658-1 contains six SAR ADCs, six track-and-hold amplifiers, an on-chip 2.5 V reference, reference buffers, and high speed parallel and serial interfaces. The parts allow the simultaneous sampling of all six ADCs when all three CONVST signals are tied together. Alternatively, the six ADCs can be grouped into three pairs. Each pair has an associated CONVST signal used to initiate simultaneous sampling on each ADC pair, on four ADCs, or on all six ADCs. CONVST A is used to initiate simultaneous sampling on V1 and V2, CONVST B is used to initiate simultaneous sampling on V3 and V4, and CONVST C is used to initiate simultaneous sampling on V5 and V6.

A conversion is initiated on the AD7656-1/AD7657-1/AD7658-1 by pulsing the CONVSTx input. On the rising edge of CONVSTx, the track-and-hold of the selected ADC pair is placed into hold mode and the conversions are started. After the rising edge of CONVSTx, the BUSY signal goes high to indicate that the conversion is taking place. The conversion clock for the AD7656-1/AD7657-1/AD7658-1 is internally generated, and the conversion time for the parts is 3  $\mu$ s. The BUSY signal returns low to indicate the end of conversion. On the falling edge of BUSY, the track-and-hold returns to track mode. Data can be read from the output register via the parallel or serial interface.

### Track-and-Hold Section

The track-and-hold amplifiers on the AD7656-1/AD7657-1/AD7658-1 allow the ADCs to accurately convert an input sine wave of full-scale amplitude to 16-/14-/12-bit resolution respectively. The input bandwidth of the track-and-hold amplifiers is greater than the Nyquist rate of the ADC, even when the AD7656-1/AD7657-1/AD7658-1 are operating at its maximum throughput rate. The parts can handle input frequencies of up to 12 MHz.

The track-and-hold amplifiers sample their respective inputs simultaneously on the rising edge of CONVSTx. The aperture time for the track-and-hold (that is, the delay time between the external CONVSTx signal actually going into hold) is 10 ns. This is well matched across all six track-and-holds on one device and from device to device. This allows more than six ADCs to be sampled simultaneously. The end of the conversion is signaled by the falling edge of BUSY, and it is at this point that the track-and-holds return to track mode and the acquisition time begins.

### Analog Input Section

The AD7656-1/AD7657-1/AD7658-1 can handle true bipolar input voltages. The logic level on the RANGE pin or the value written to the RNGx bits in the control register determines the analog input range on the AD7656-1/AD7657-1/AD7658-1 for the next conversion. When the RANGE pin/RNGx bit is 1, the analog input range for the next conversion is  $\pm 2 \times V_{REF}$ . When the RANGE pin/RNGx bit is 0, the analog input range for the next conversion is  $\pm 4 \times V_{REF}$ .

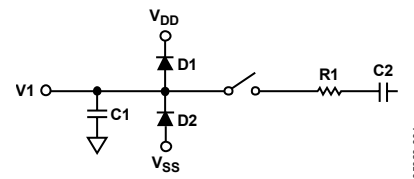

Figure 24. Equivalent Analog Input Structure

Figure 24 shows an equivalent circuit of the analog input structure of the AD7656-1/AD7657-1/AD7658-1. The two diodes, D1 and D2, provide ESD protection for the analog inputs. Care must be taken to ensure that the analog input signal never exceeds the  $V_{DD}$  and  $V_{SS}$  supply rails by more than 300 mV. Signals exceeding this value cause these diodes to become forward-biased and to start conducting current into the substrate. The maximum current these diodes can conduct without causing irreversible damage to the parts is 10 mA. Capacitor C1 in Figure 24 is typically about 4 pF and can be attributed primarily to pin capacitance. Resistor R1 is a lumped component made up of the on resistance of a switch (track-and-hold switch). This resistor is typically about 25  $\Omega$ . Capacitor C2 is the ADC sampling capacitor and has a capacitance of 10 pF typically.

The AD7656-1/AD7657-1/AD7658-1 require  $V_{DD}$  and  $V_{SS}$  dual supplies for the high voltage analog input structures. These supplies must be equal to or greater than the analog input range (see Table 8 for the requirements on these supplies for each analog input range). The AD7656-1/AD7657-1/AD7658-1 require a low voltage  $AV_{CC}$  supply of 4.75 V to 5.25 V to power the ADC core, a  $DV_{CC}$  supply of 4.75 V to 5.25 V for the digital power, and a  $V_{DRIVE}$  supply of 2.7 V to 5.25 V for the interface power.

To meet the specified performance when using the minimum supply voltage for the selected analog input range, it can be necessary to reduce the throughput rate from the maximum throughput rate.

Table 8. Minimum  $V_{DD}/V_{SS}$  Supply Voltage Requirements

Analog Input Range (V)	Reference Voltage (V)	Full Scale Input (V)	Minimum $V_{DD}/V_{SS}$ (V)
$\pm 4 \times V_{REF}$	+2.5	$\pm 10$	$\pm 10$
$\pm 4 \times V_{REF}$	+3.0	$\pm 12$	$\pm 12$

$\pm 2 \times V_{REF}$	+2.5	$\pm 5$	$\pm 5$
$\pm 2 \times V_{REF}$	+3.0	$\pm 6$	$\pm 6$

### ADC TRANSFER FUNCTION

The output coding of the AD7656-1/AD7657-1/AD7658-1 is two's complement. The designed code transitions occur midway between successive integer LSB values, that is, 1/2 LSB, 3/2 LSB. The LSB size is FSR/65,536 for the AD7656-1, FSR/16384 for the AD7657-1, and FSR/4096 for the AD7658-1. The ideal transfer characteristic is shown in Figure 25.

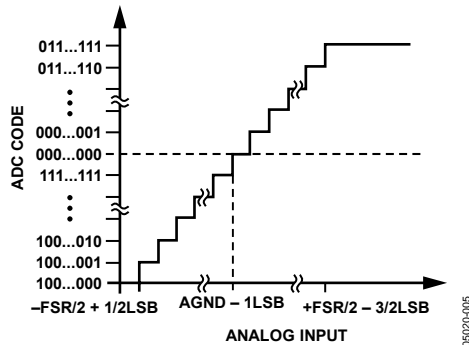

Figure 25. AD7656-1/AD7657-1/AD7658-1 Transfer Characteristic

The LSB size is dependent on the analog input range selected (see Table 9).

### REFERENCE SECTION

The RFIN/REFOUT pin either allows access to the AD7656-1/AD7657-1/AD7658-1's 2.5 V reference or it allows an external reference to be connected, providing the reference source for each part's conversions. The AD7656-1/AD7657-1/AD7658-1 can accommodate a 2.5 V to 3 V external reference range. When using an external reference, the internal reference needs to be disabled. After a reset, the AD7656-1/AD7657-1/AD7658-1 default to operating in external reference mode with the internal reference buffers enabled. The internal reference can be enabled in either hardware or software mode. To enable the internal reference in hardware mode, the  $\overline{H/S SEL}$  pin = 0 and the REF EN/DIS pin = 1. To enable the internal reference in software mode,  $\overline{H/S SEL}$  = 1 and a write to the control register is necessary to make DB9 of the register = 1. For the internal reference mode,

Table 9. LSB Size for Each Analog Input Range

Range	AD7656-1		AD7657-1		AD7658-1	
Input Range	$\pm 10$ V	$\pm 5$ V	$\pm 10$ V	$\pm 5$ V	$\pm 10$ V	$\pm 5$ V
LSB Size	0.305 mV	0.152 mV	1.22 mV	0.610 mV	4.88 mV	2.44mV
FS Range	20 V/65,536	10 V/65,536	20 V/16384	10 V/16384	20 V/4096	10 V/4096

the RFIN/REFOUT pin should be decoupled using a 1  $\mu$ F capacitor.

The AD7656-1/AD7657-1/AD7658-1 contain three on-chip reference buffers. Each of the three ADC pairs has an associated reference buffer. These reference buffers require external decoupling capacitors on REFCAPA, REFCAPB, and REFCAPC pins, and 1  $\mu$ F decoupling capacitors should be placed on these REFCAP pins. The internal reference buffers can be disabled in software mode by writing to Bit DB8 in the internal control register. If operating the devices in serial mode,

the internal reference buffers can be disabled in hardware mode by setting the DB14/REFBUF $\overline{EN}_{DIS}$  pin high. If the internal reference and its buffers are disabled, an external buffered reference should be applied to the REFCAP pins.

### TYPICAL CONNECTION DIAGRAM

Figure 26 shows the typical connection diagram for the AD7656-1/AD7657-1/AD7658-1. There are eight AV<sub>CC</sub> supply pins on the parts. The AV<sub>CC</sub> supply is the supply that is used for the AD7656-1/AD7657-1/AD7658-1 conversion process, therefore, it should be well decoupled. The AV<sub>CC</sub> supply pins should be decoupled using a 1  $\mu$ F capacitor. The AD7656-1/AD7657-1/AD7658-1 can operate with the internal reference or an externally applied reference. In this configuration, the parts are configured to operate with the external reference. The RFIN/REFOUT pin is decoupled with a 1  $\mu$ F cap. The three internal reference buffers are enabled. Each of the REFCAP pins are decoupled with a 1  $\mu$ F capacitor.

If the same supply is being used for the AV<sub>CC</sub> supply and DV<sub>CC</sub> supply, a ferrite or small RC filter should be placed between the supply pins.

AGND pins are connected to the AGND plane of the system. The DGND pins are connected to the digital ground plane in the system. The AGND and DGND planes should be connected together at one place in the system. This connection should be made as close as possible to the AD7656-1/AD7657-1/AD7658-1 in the system.

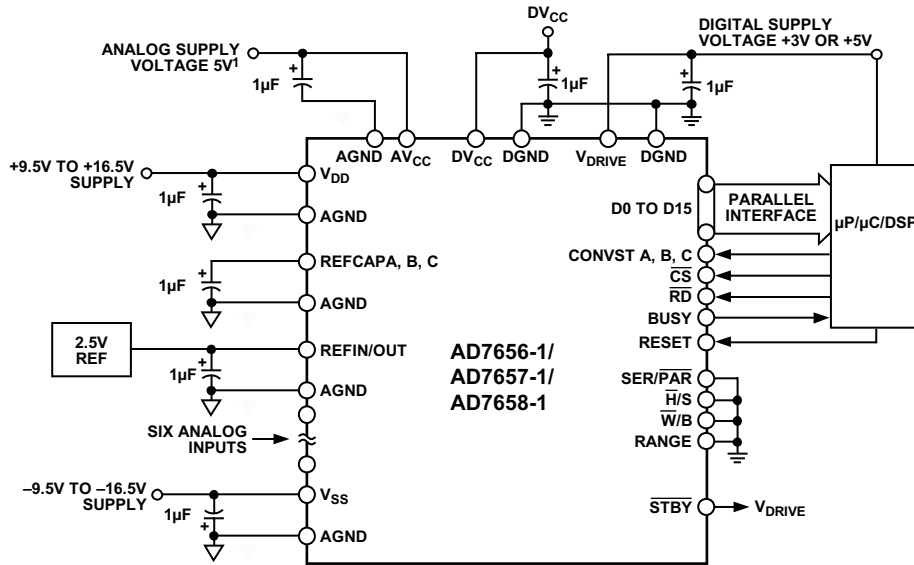

Figure 26. Typical Connection Diagram

The  $V_{DRIVE}$  supply is connected to the same supply as the processor. The voltage on  $V_{DRIVE}$  controls the voltage value of the output logic signals.

The  $V_{DD}$  and  $V_{SS}$  signals should be decoupled with a minimum 1  $\mu\text{F}$  decoupling capacitor. These supplies are used for the high voltage analog input structures on the AD7656-1/AD7657-1/AD7658-1 analog inputs.

## DRIVING THE ANALOG INPUTS

Together, the driver amplifier and the analog input circuit used for the AD7656-1 must settle for a full-scale step input to a 16-bit level (0.0015%), which is within the specified 550 ns acquisition time of the AD7656-1. The noise generated by the driver amplifier needs to be kept as low as possible in order to preserve the SNR and transition noise performance of the AD7656-1.

The driver also needs to have a THD performance suitable to that of the AD7656-1. The AD8021 meets all these requirements. The AD8021 needs an external compensation capacitor of 10 pF. If a dual version of the AD8021 is required, the AD8022 can be used. The AD8610 and the AD797 can also be used to drive the AD7656-1/AD7657-1/AD7658-1.

## INTERFACE SECTION

The AD7656-1/AD7657-1/AD7658-1 provide two interface options, a parallel interface and a high speed serial interface. The required interface mode is selected via the SER/PAR pin. The parallel interface can operate in word ( $\overline{W/B} = 0$ ) or byte ( $\overline{W/B} = 1$ ) mode. The interface modes are discussed in the following sections.

### Parallel Interface ( $\overline{SER/PAR} = 0$ )

The AD7656-1/AD7657-1/AD7658-1 consist of six 16-/14-/12-bit ADCs respectively. A simultaneous sample of all six ADCs can be performed by connecting all three CONVST pins together, CONVST A, CONVST B, and CONVST C. The AD7656-1/AD7657-1/AD7658-1 need to see a CONVST pulse in order to initiate a conversion; this should consist of a falling CONVST edge followed by a rising CONVST edge. The rising edge of CONVSTx initiates simultaneous conversions on the selected ADCs. The AD7656-1/AD7657-1/AD7658-1 contain an on-chip oscillator that is used to perform the conversions. The conversion time,  $t_{CONV}$ , is 3  $\mu\text{s}$ . The BUSY signal goes low to indicate the end of conversion. The falling edge of the BUSY signal is used to place the track-and-hold into track mode. The AD7656-1/AD7657-1/AD7658-1 also allow the six ADCs to be converted simultaneously in pairs by pulsing the three CONVST pins independently. CONVST A is used to initiate simultaneous conversions on V1 and V2, CONVST B is used to initiate simultaneous conversions on V3 and V4, and CONVST C is used to initiate simultaneous conversions on V5 and V6. The conversion results from the simultaneously sampled ADCs are stored in the output data registers.

Data can be read from the AD7656-1/AD7657-1/AD7658-1 via the parallel data bus with standard  $\overline{CS}$  and  $\overline{RD}$  signals ( $\overline{W/B} = 0$ ). To read the data over the parallel bus, SER/PAR should be tied low. The  $\overline{CS}$  and  $\overline{RD}$  input signals are internally gated to enable the conversion result onto the data bus. The data lines DB0 to DB15 leave their high impedance state when both  $\overline{CS}$  and  $\overline{RD}$  are logic low.

The  $\overline{CS}$  signal can be permanently tied low, and the  $\overline{RD}$  signal can be used to access the conversion results. A read operation can take place after the BUSY signal goes low. The number of required read operations depends on the number of ADCs that are simultaneously sampled (see Figure 27). If CONVST A and CONVST B are simultaneously brought low, four read operations are required to obtain the conversion results from V1, V2, V3, and V4. If CONVST A and CONVST C are simultaneously brought low, four read operations are required to obtain the conversion results from V1, V2, V5, and V6. The conversion results are output in ascending order. For the AD7657, DB15 and DB14 contain two leading zeros and DB[13:0] output the 14-bit conversion result. For the AD7658, DB[15:12] contain four leading zeros and DB[11:0] output the 12-bit conversion result.

When using the three CONVST signals to independently initiate conversions on the three ADC pairs, care should be taken to ensure that a conversion is not initiated on a channel pair when the BUSY signal is high. It is also recommended not to initiate a conversion during a read sequence because doing so

can affect the performance of the conversion. For the specified performance, it is recommended to perform the read after the conversion. For unused input channel pairs, the associated CONVSTx pin should be tied to  $V_{DRIVE}$ .

If there is only an 8-bit bus available, the AD7656-1/AD7657-1/AD7658-1 interface can be configured to operate in byte mode ( $\overline{W}/B = 1$ ). In this configuration, the DB7/HBEN/DCEN pin takes on its HBEN function. Each channel conversion result from the AD7656-1/AD7657-1/AD7658-1 can be accessed in two read operations, with 8-bits of data provided on DB15 to DB8 for each of the read operations (see Figure 28). The HBEN pin determines whether the read operation first accesses the high byte or the low byte of the 16-bit conversion result. To always access the low byte first on DB15 to DB8, the HBEN pin should be tied low. To always access the high byte first on DB15 to DB8, the HBEN pin should be tied high. In byte mode when all three CONVST pins are pulsed together to initiate simultaneous conversions on all six ADCs, 12 read operations are necessary to read back the six 16-/14-/12-bit conversion results. DB[6:0] should be left unconnected in byte mode.

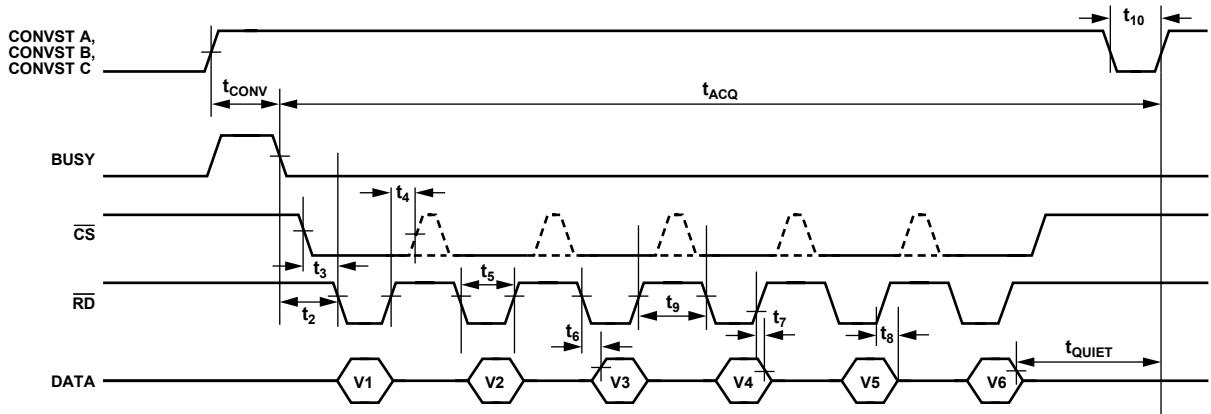

Figure 27. Parallel Interface Timing Diagram ( $\overline{W}/B = 0$ )

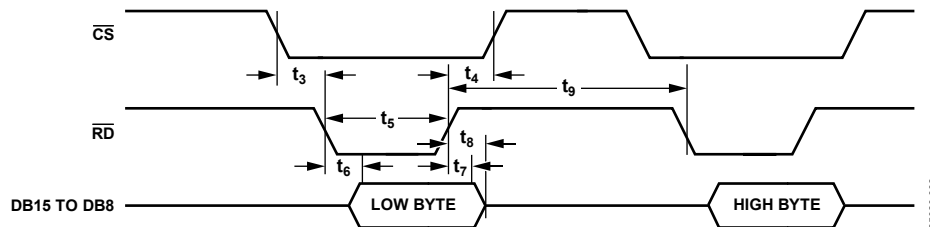

Figure 28. Parallel Interface—Read Cycle for Byte Mode of Operation. ( $\overline{W}/B = 1$ , HBEN = 0)

**Software Selection of ADCs**

The  $\overline{H/S}$  SEL pin determines the source of the combination of ADCs that are to be simultaneously sampled. When the  $\overline{H/S}$  SEL pin is logic low, the combination of channels to be simultaneously sampled is determined by the  $\overline{CONVST}$  A,  $\overline{CONVST}$  B, and  $\overline{CONVST}$  C pins. When the  $\overline{H/S}$  SEL pin is logic high, the combination of channels selected for simultaneous sampling is determined by the contents of the Control Register DB15 to Control Register DB13. In this mode, a write to the control register is necessary.

The control register is an 8-bit write only register. Data is written to this register using the  $\overline{CS}$  and  $\overline{WR}$  pins and the DB[15:8] data pins (see Figure 29). The control register is shown in Table 10. To select an ADC pair to be simultaneously sampled, set the corresponding data line high during the write operation.

The AD7656-1/AD7657-1/AD7658-1 control register allows individual ranges to be programmed on each ADC pair. DB12 to DB10 in the control register are used to program the range on each ADC pair.

After a reset occurs on the AD7656-1/AD7657-1/AD7658-1, the control register contains all zeros.

The  $\overline{CONVST}$  A signal is used to initiate a simultaneous conversion on the combination of channels selected via the control register. The  $\overline{CONVST}$  B and  $\overline{CONVST}$  C signals can be tied low when operating in software mode ( $\overline{H/S}$  SEL = 1). The number of read pulses required depends on the number of ADCs selected in the control register and on whether the devices are operating in word or byte mode. The conversion results are output in ascending order.

During the write operation, Data Bus Bit DB15 to Bit DB8 are bidirectional and become inputs to the control register when  $\overline{RD}$  is logic high and  $\overline{CS}$  and  $\overline{WR}$  are logic low. The logic state on DB15 through DB8 is latched into the control register when  $\overline{WR}$  goes logic high.

**Table 10. Control Register Bit Function Descriptions (Default All 0s)**

DB15	DB14	DB13	DB12	DB11	DB10	DB9	DB8
VC	VB	VA	RNGC	RNGB	RNGA	REFEN	REFBUF

**Table 11.**

Bit	Mnemonic	Comment
DB15	VC	This bit is used to select Analog Inputs V5 and V6 for the next conversion. When this bit = 1, V5 and V6 are simultaneously converted on the next $\overline{CONVST}$ A rising edge.
DB14	VB	This bit is used to select Analog Inputs V3 and V4 for the next conversion. When this bit = 1, V3 and V4 are simultaneously converted on the next $\overline{CONVST}$ A rising edge.
DB13	VA	This bit is used to select Analog Inputs V1 and V2 for the next conversion. When this bit = 1, V1 and V2 are simultaneously converted on the next $\overline{CONVST}$ A rising edge.
DB12	RNGC	This bit is used to select the analog input range for Analog Inputs V5 and V6. When this bit = 1, the $\pm 2 \times V_{REF}$ mode is selected for the next conversion. When this bit = 0, the $\pm 4 \times V_{REF}$ mode is selected for the next conversion.
DB11	RNGB	This bit is used to select the analog input range for Analog Inputs V3 and V4. When this bit = 1, the $\pm 2 \times V_{REF}$ mode is selected for the next conversion. When this bit = 0, the $\pm 4 \times V_{REF}$ mode is selected for the next conversion.
DB10	RNGA	This bit is used to select the analog input range for Analog Inputs V1 and V2. When this bit = 1, the $\pm 2 \times V_{REF}$ mode is selected for the next conversion. When this bit = 0, the $\pm 4 \times V_{REF}$ mode is selected for the next conversion.
DB9	REFEN	This bit is used to select the internal reference or an external reference. When this bit = 0, the external reference mode is selected. When this bit = 1, the internal reference is selected.
DB8	REFBUF	This bit is used to select between using the internal reference buffers and choosing to bypass these reference buffers. When this bit = 0, the internal reference buffers are enabled and decoupling is required on the REFCAP pins. When this bit = 1, the internal reference buffers are disabled and a buffered reference should be applied to the REFCAP pins.

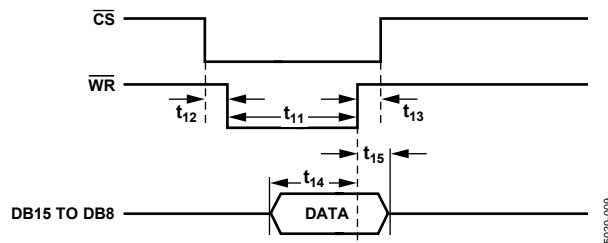

Figure 29. Parallel Interface—Write Cycle for Word Mode ( $\overline{W}/B=0$ )



**Changing the Analog Input Range ( $\overline{H/S SEL} = 0$ )**

The AD7656-1/AD7657-1/AD7658-1 RANGE pin allows the user to select either  $\pm 2 \times V_{REF}$  or  $\pm 4 \times V_{REF}$  as the analog input range for the six analog inputs. When the  $\overline{H/S SEL}$  pin is low, the logic state of the RANGE pin is sampled on the falling edge of the BUSY signal to determine the range for the next simultaneous conversion. When the RANGE pin is logic high at the falling edge of the BUSY signal, the range for the next conversion is

$\pm 2 \times V_{REF}$ . When the RANGE pin is logic low at the falling edge of the BUSY signal, the range for the next conversion is  $\pm 4 \times V_{REF}$ . After a RESET pulse, the range is updated on the first falling BUSY edge after the RESET pulse.

**Changing the Analog Input Range ( $\overline{H/S SEL} = 1$ )**

When the  $\overline{H/S SEL}$  pin is high, the range can be changed by writing to the control register. DB[12:10] in the control register are used to select the analog input ranges for the next conversion. Each analog input pair has an associated range bit, allowing independent ranges to be programmed on each ADC pair. When the RNGx bit = 1, the range for the next conversion is  $\pm 2 \times V_{REF}$ . When the RNGx bit = 0, the range for the next conversion is  $\pm 4 \times V_{REF}$ .

**Serial Interface ( $\overline{SER/PAR} = 1$ )**

By pulsing one, two, or all three CONVSTx signals, the AD7656-1/AD7657-1/AD7658-1 use their on-chip trimmed oscillator to simultaneously convert the selected channel pairs on the rising edge of CONVSTx. After the rising edge of CONVSTx, the BUSY signal goes high to indicate that the conversion has started. It returns low when the conversion is complete 3  $\mu$ s later. The output register is loaded with the new conversion results, and data can be read from the AD7656-1/AD7657-1/AD7658-1. To read the data back from the parts over the serial interface,  $\overline{SER/PAR}$  should be tied high. The  $\overline{CS}$  and SCLK signals are used to transfer data from the AD7656-1/AD7657-1/AD7658-1. The parts have three DOUT pins, DOUT A, DOUT B, and DOUT C. Data can be read back from the each part using one, two, or all three DOUT lines.

Figure 30 shows six simultaneous conversions and the read sequence using three DOUT lines. Also in Figure 30, 32 SCLK transfers are used to access data from the AD7656-1/AD7657-1/AD7658-1; however, two 16 SCLK individually framed transfers with the  $\overline{CS}$  signal can also be used to access the data on the three DOUT lines. When operating the AD7656-1/AD7657-1/AD7658-1 in serial mode with conversion data clocking out on all three DOUT lines, DB0/SEL A, DB1/SEL B, and DB2/SEL C should be tied to  $V_{DRIVE}$ . These pins are used to enable the DOUT A to DOUT C lines, respectively.

If it is required to clock conversion data out on two data out lines, DOUT A and DOUT B should be used. To enable DOUT A and DOUT B, DB0/SEL A and DB1/SEL B should be tied to  $V_{DRIVE}$  and DB2/SEL C should be tied low. When six simultaneous conversions are performed and only two DOUT lines are used, a 48 SCLK transfer can be used to access the data from the AD7656-1/AD7657-1/AD7658-1. The read sequence is shown in Figure 31 for a simultaneous conversion on all six ADCs using two DOUT lines. If a simultaneous conversion occurred on all six ADCs, and only two DOUT lines are used to read the results from the AD7656-1/AD7657-1/AD7658-1, DOUT A clocks out the result from V1, V2, and V5, while DOUT B clocks out the results from V3, V4, and V6.

Data can also be clocked out using just one DOUT line, in which case DOUT A should be used to access the conversion data. To configure the AD7656-1/AD7657-1/AD7658-1 to operate in this mode, DB0/SEL A should be tied to  $V_{DRIVE}$  and DB1/SEL B and DB2/SEL C should be tied low. The disadvantage of using just one DOUT line is that the throughput rate is reduced. Data can be accessed from the AD7656-1/AD7657-1/AD7658-1 using one 96 SCLK transfer, three 32 SCLK individually framed transfers, or six 16 SCLK individually framed transfers. In serial mode, the RD signal should be tied low. The unused DOUT line(s) should be left unconnected in serial mode.

**Serial Read Operation**

Figure 32 shows the timing diagram for reading data from the AD7656-1/AD7657-1/AD7658-1 in serial mode. The SCLK input signal provides the clock source for the serial interface. The  $\overline{CS}$  signal goes low to access data from the AD7656-1/AD7657-1/AD7658-1. The falling edge of  $\overline{CS}$  takes the bus out of three-state and clocks out the MSB of the 16-bit conversion result. The ADCs output 16 bits for each conversion result; the data stream of the AD7656-1 consists of 16 bits of conversion data provided MSB first. The data stream for the AD7657-1 consists of two leading zeros followed by 14 bits of conversion data MSB first. The data stream for the AD7658-1 consists of four leading zeros and 12 bits of conversion data provided MSB first.

The first bit of the conversion result is valid on the first SCLK falling edge after the  $\overline{CS}$  falling edge. The subsequent 15 data bits are clocked out on the rising edge of the SCLK signal. Data is valid on the SCLK falling edge. To access each conversion result, 16 clock pulses must be provided to the AD7656-1/AD7657-1/AD7658-1. Figure 32 shows how a 16 SCLK read is used to access the conversion results.

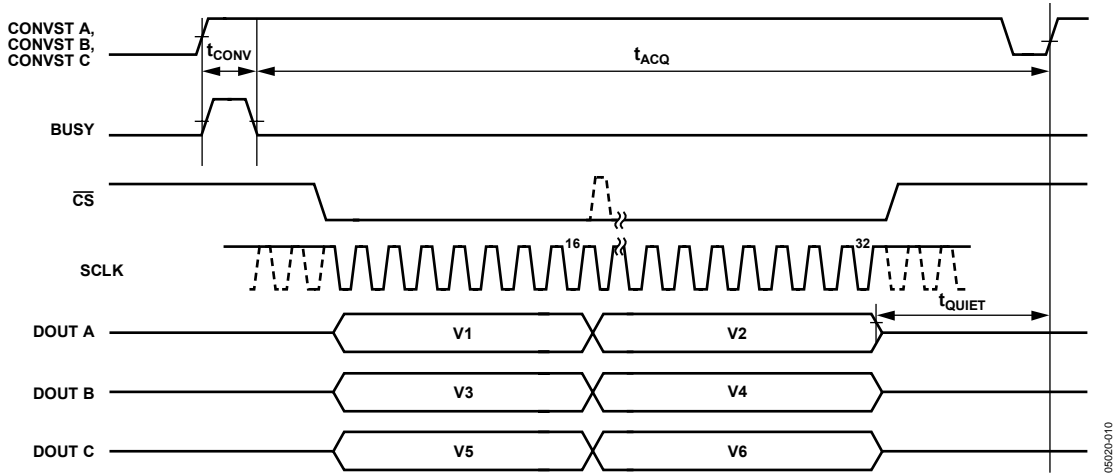

Figure 30. Serial Interface with Three DOUT Lines

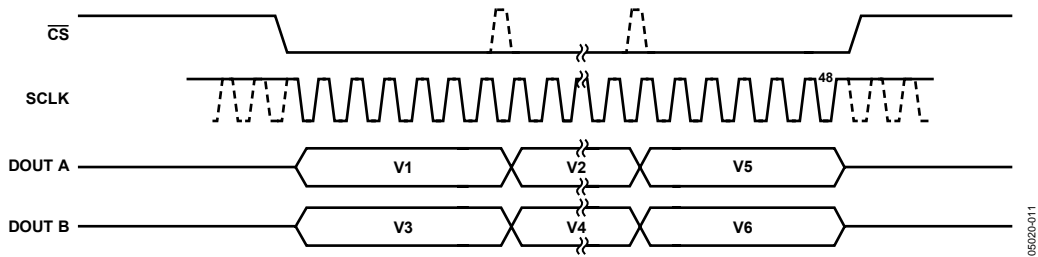

Figure 31. Serial Interface with Two DOUT Lines

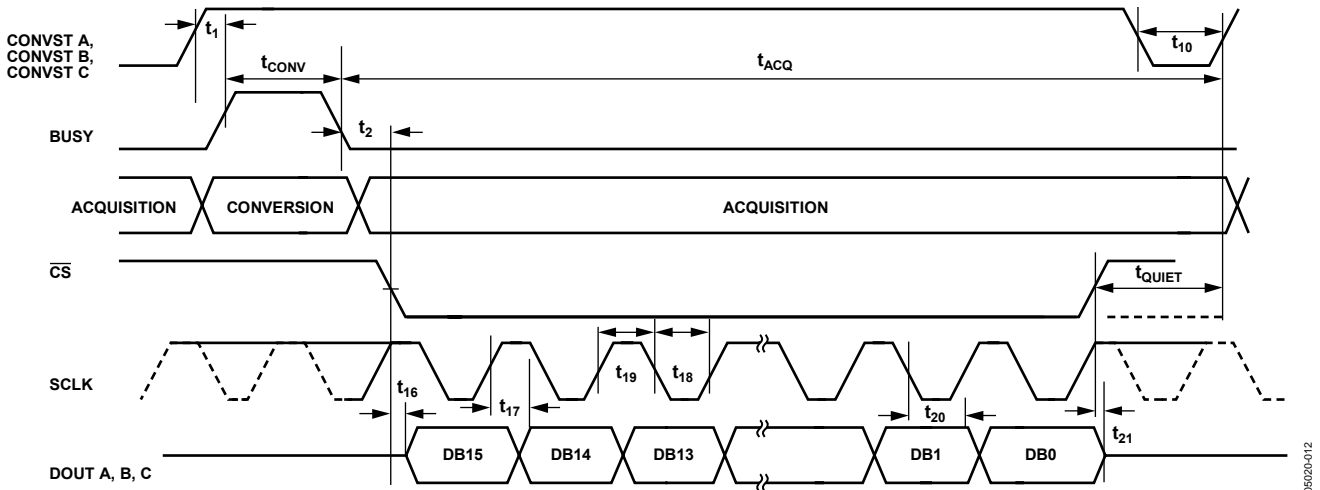

Figure 32. Serial Read Operation

**Daisy-Chain Mode (DCEN = 1, SER/PAR = 1)**

When reading conversion data back from the AD7656-1/AD7657-1/AD7658-1 using their three/two/one DOUT pins, it is possible to configure the parts to operate in daisy-chain mode, using the DCEN pin. This daisy-chain feature allows multiple AD7656-1/AD7657-1/AD7658-1 devices to be cascaded together and is useful for reducing component count and wiring connections. An example connection of two devices is shown in Figure 33. This configuration shows two DOUT lines being used. Simultaneous sampling of the 12 analog inputs is possible by using a common CONVSTx signal. The DB5, DB4, and DB3 data pins are used as data input pins DCIN [A:C] for the daisy-chain mode.

The rising edge of CONVST is used to initiate a conversion on the AD7656-1/AD7657-1/AD7658-1. After the BUSY signal has gone low to indicate that the conversion is complete, the user can begin to read the data from the two devices. Figure 34 shows the serial timing diagram when operating two AD7656-1/AD7657-1/AD7658-1 devices in daisy-chain mode.

The  $\overline{\text{CS}}$  falling edge is used to frame the serial transfer from the AD7656-1/AD7657-1/AD7658-1 devices, to take the bus out of three-state, and to clock out the MSB of the first conversion result. In the example shown in Figure 34, all 12 ADC channels are simultaneously sampled. Two DOUT lines are used to read the conversion results in this example.  $\overline{\text{CS}}$  frames a 96 SCLK transfer. During the first 48 SCLKs, the conversion data is transferred from Device 2 to Device 1. DOUT A on Device 2 transfers conversion data from V1, V2, and V5 into DCIN A in Device 1. DOUT B on Device 2 transfers conversion results from V3, V4, and V6 to DCIN B in Device 1. During the first 48 SCLKs, Device 1 transfers data into the digital host. DOUT A on Device 1 transfers conversion data from V1, V2, and V5. DOUT B on Device 1 transfers conversion data from V3, V4, and V6. During the last 48 SCLKs, Device 2 clocks out zeros and Device 1 shifts the data clocked in from Device 2 during the first 48 SCLKs into the digital host. This example can also be implemented using six 16 SCLK individually framed transfers if DCEN remains high during the transfers.

Figure 35 shows the timing if two AD7656-1/AD7657-1/AD7658-1 devices are configured in daisy-chain mode and are operating with three DOUT lines. Assuming a simultaneous sampling of all 12 inputs occurs, the  $\overline{\text{CS}}$  frames a 64 SCLK transfer during the read operation. During the first 32 SCLKs of this transfer, the conversion results from Device 1 are clocked into the digital host and the conversion results from Device 2 are clocked into Device 1. During the last 32 SCLKs of the transfer, the conversion results from Device 2 are clocked out of Device 1 and into the digital host. Device 2 clocks out zeros.

**Standby/Partial Power-Down Modes of Operation**

Each ADC pair can be individually placed into partial power-down mode by bringing the CONVSTx signal low before the falling edge of BUSY. To power the ADC pair back up, the CONVSTx signal should be brought high to tell the ADC pair to power up and place the track-and-hold into track mode. After the power-up time from partial power-down has elapsed, the CONVSTx signal should receive a rising edge to initiate a valid conversion. In partial power-down mode, the reference buffers remain powered up. While an ADC pair is in partial power-down mode, conversions can still occur on the other ADCs.

The AD7656-1/AD7657-1/AD7658-1 have a standby mode whereby the devices can be placed into a low power consumption mode (100  $\mu\text{W}$  max). The AD7656-1/AD7657-1/AD7658-1 are placed into standby mode by bringing the logic input  $\overline{\text{STBY}}$  low and can be powered up again for normal operation by bringing  $\overline{\text{STBY}}$  logic high. The output data buffers are still operational when the AD7656-1/AD7657-1/AD7658-1 are in standby mode, meaning the user can continue to access the conversion results of the parts. This standby feature can be used to reduce the average power consumed by the AD7656-1/AD7657-1/AD7658-1 when operating at lower throughput rates. The parts can be placed into standby at the end of each conversion when BUSY goes low and taken out of standby again prior to the next conversion. The time for the AD7656-1/AD7657-1/AD7658-1 to come out of standby is called the wake-up time. The wake-up time limits the maximum throughput rate at which the AD7656-1/AD7657-1/AD7658-1 can operate when powering down between conversions. See the Specifications section.

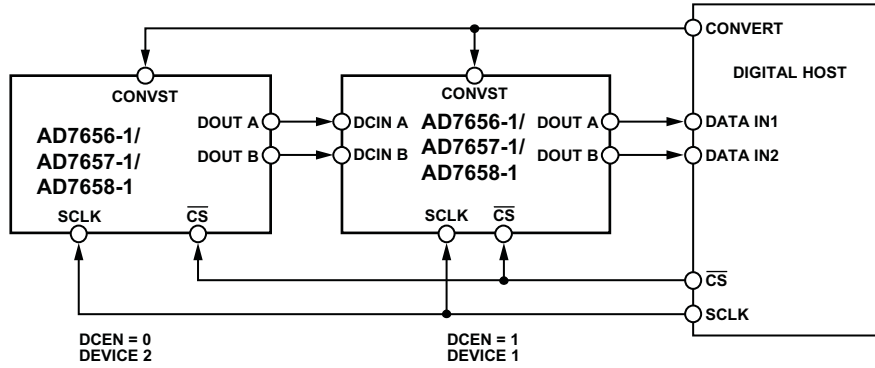

Figure 33. Daisy-Chain Configuration

05020-013

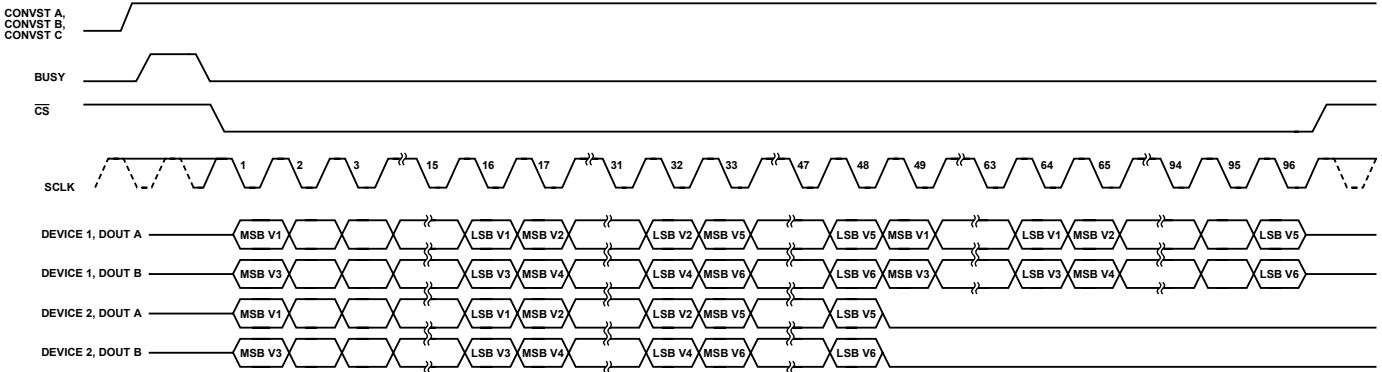

Figure 34. Daisy-Chain Serial Interface Timing with Two DOUT Lines

05020-014

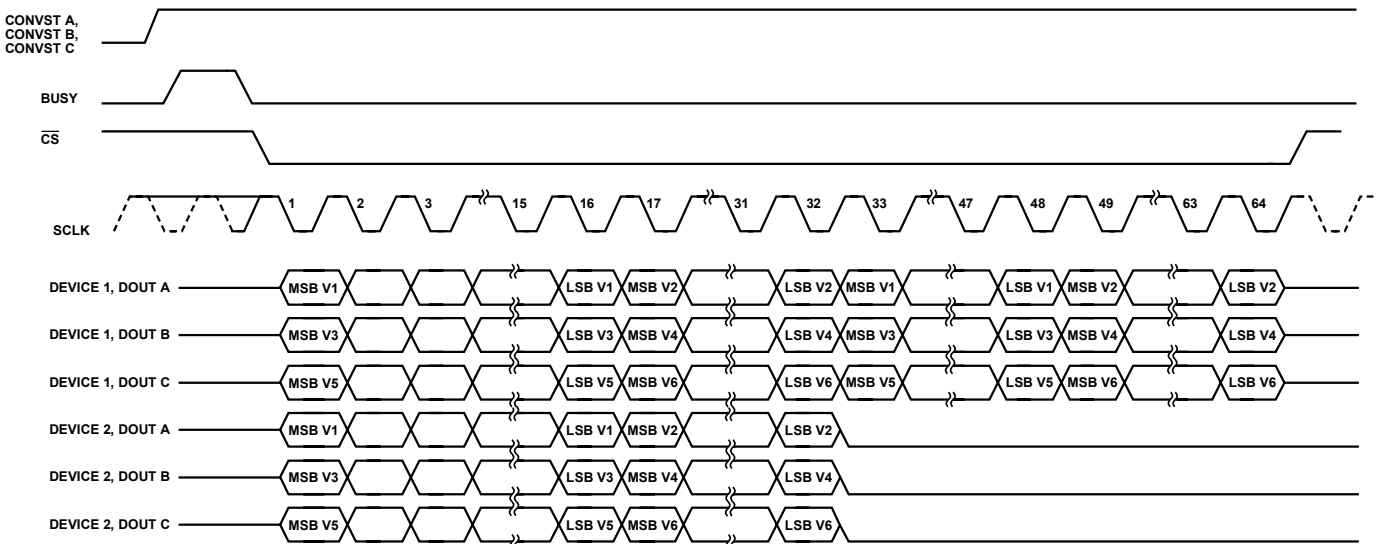

Figure 35. Daisy-Chain Serial Interface Timing with Three DOUT Lines

05020-015

## APPLICATION HINTS

### LAYOUT

The printed circuit board that houses the AD7656-1/AD7657-1/AD7658-1 should be designed so that the analog and digital sections are separated and confined to certain areas of the board.

At least one ground plane should be used. It could be common or split between the digital and analog sections. In the case of the split plane, the digital and analog ground planes should be joined in only one place, preferably underneath the AD7656-1/AD7657-1/AD7658-1, or at least as close as possible to each part.

If the AD7656-1/AD7657-1/AD7658-1 are in a system where multiple devices require analog-to-digital ground connections, the connection should still be made at only one point, a star ground point, which should be established as close as possible to the AD7656-1/AD7657-1/AD7658-1. Good connections should be made to the ground plane. Avoid sharing one connection for multiple ground pins. Individual vias or multiple vias to the ground plane should be used for each ground pin.

Avoid running digital lines under the devices because doing so couples noise onto the die. The analog ground plane should be allowed to run under the AD7656-1/AD7657-1/AD7658-1 to avoid noise coupling. Fast-switching signals like CONVST or clocks should be shielded with digital ground to avoid radiating noise to other sections of the board, and they should never run

near analog signal paths. Crossover of digital and analog signals should be avoided. Traces on different but close layers of the board should run at right angles to each other to reduce the effect of feedthrough through the board.

The power supply lines to the  $AV_{CC}$ ,  $DV_{CC}$ ,  $V_{DRIVE}$ ,  $V_{DD}$ , and  $V_{SS}$  pins on the AD7656-1/AD7657-1/AD7658-1 should use as large a trace as possible to provide low impedance paths and reduce the effect of glitches on the power supply lines. Good connections should be made between the AD7656-1/AD7657-1/AD7658-1 supply pins and the power tracks on the board; this should involve the use of a single via or multiple vias for each supply pin.

Good decoupling is also important to lower the supply impedance presented to the AD7656-1/AD7657-1/AD7658-1 and to reduce the magnitude of the supply spikes. The decoupling capacitors should be placed close to, ideally right up against, these pins and their corresponding ground pins. Additionally, low ESR 1  $\mu$ F capacitors should be placed on each of the supply pins, REFINOUT and each REFCAP pin. Avoid sharing these capacitors between pins. Use big vias to connect the capacitors to the power and ground planes. Use wide, short traces between the via and the capacitor pad, or place the via adjacent to the capacitor pad to minimize parasitic inductances. Recommended decoupling is outlined in Figure 26.

OUTLINE DIMENSIONS

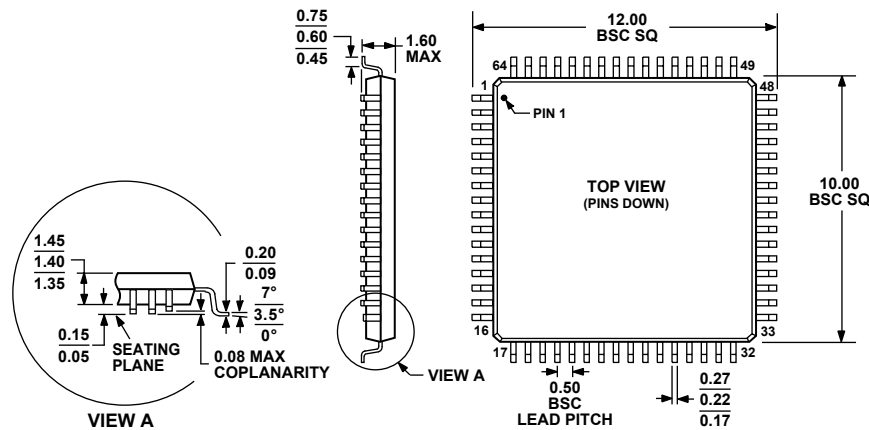

COMPLIANT TO JEDEC STANDARDS MS-026-BCD

Figure 36. 64-Lead Low Profile Quad Flat Package [LQFP] (ST-64-2)

Dimensions shown in millimeters

ORDERING GUIDE

Model	Temperature Range	Package Description	Package Option
AD7656-1BST	-40°C to +85°C	64-Lead Low Profile Quad Flat Package [LQFP]	ST-64-2
AD7656-1BST-500RL7	-40°C to +85°C	64-Lead Low Profile Quad Flat Package [LQFP]	ST-64-2
AD7656-1BSTZ <sup>1</sup>	-40°C to +85°C	64-Lead Low Profile Quad Flat Package [LQFP]	ST-64-2
AD7656-1BSTZ-REEL <sup>1</sup>	-40°C to +85°C	64-Lead Low Profile Quad Flat Package [LQFP]	ST-64-2
AD7656-1BSTZ-500RL7 <sup>1</sup>	-40°C to +85°C	64-Lead Low Profile Quad Flat Package [LQFP]	ST-64-2
AD7656-1YSTZ <sup>1</sup>	-40°C to +125°C	64-Lead Low Profile Quad Flat Package [LQFP]	ST-64-2
AD7656-1YSTZ-REEL <sup>1</sup>	-40°C to +125°C	64-Lead Low Profile Quad Flat Package [LQFP]	ST-64-2
AD7656-1YSTZ-500RL7 <sup>1</sup>	-40°C to +125°C	64-Lead Low Profile Quad Flat Package [LQFP]	ST-64-2
AD7657-1BSTZ <sup>1</sup>	-40°C to +85°C	64-Lead Low Profile Quad Flat Package [LQFP]	ST-64-2
AD7657-1BSTZ-REEL <sup>1</sup>	-40°C to +85°C	64-Lead Low Profile Quad Flat Package [LQFP]	ST-64-2
AD7657-1BSTZ-500RL7 <sup>1</sup>	-40°C to +85°C	64-Lead Low Profile Quad Flat Package [LQFP]	ST-64-2
AD7657-1YSTZ <sup>1</sup>	-40°C to +125°C	64-Lead Low Profile Quad Flat Package [LQFP]	ST-64-2
AD7657-1YSTZ-REEL <sup>1</sup>	-40°C to +125°C	64-Lead Low Profile Quad Flat Package [LQFP]	ST-64-2
AD7657-1YSTZ-500RL7 <sup>1</sup>	-40°C to +125°C	64-Lead Low Profile Quad Flat Package [LQFP]	ST-64-2
AD7658-1BSTZ <sup>1</sup>	-40°C to +85°C	64-Lead Low Profile Quad Flat Package [LQFP]	ST-64-2
AD7658-1BSTZ-REEL <sup>1</sup>	-40°C to +85°C	64-Lead Low Profile Quad Flat Package [LQFP]	ST-64-2
AD7658-1BSTZ-500RL7 <sup>1</sup>	-40°C to +85°C	64-Lead Low Profile Quad Flat Package [LQFP]	ST-64-2
AD7658-1YSTZ <sup>1</sup>	-40°C to +125°C	64-Lead Low Profile Quad Flat Package [LQFP]	ST-64-2
AD7658-1YSTZ-REEL <sup>1</sup>	-40°C to +125°C	64-Lead Low Profile Quad Flat Package [LQFP]	ST-64-2
AD7658-1YSTZ-500RL7 <sup>1</sup>	-40°C to +125°C	64-Lead Low Profile Quad Flat Package [LQFP]	ST-64-2

<sup>1</sup> Z = Pb-free part.

**NOTES**

**NOTES**